

Thames Tideway Tunnel
Thames Water Utilities Limited



Application for Development Consent

Application Reference Number: WWO10001

Navigational Issues and Preliminary Risk Assessment

Doc Ref: **7.20.01**

Putney Embankment Foreshore

APFP Regulations 2009: Regulation **5(2)(q)**

Hard copy available in

Box **57** Folder **A**
January 2013

**Thames
Tideway Tunnel**



Creating a cleaner, healthier River Thames

This page is intentionally left blank

Thames Tideway Tunnel

Navigational Issues and Preliminary Risk Assessment: Putney Embankment Foreshore

List of contents

	Page number
1 Executive summary	1
1.1 Purpose	1
1.2 Issues to be addressed	1
1.3 Interaction with existing river users.....	2
1.4 Proximity to Putney Bridge and bridge arch closures	2
1.5 Impact on operations at Putney Pier.....	3
1.6 Impact on vessels moored in vicinity of new discharge outfall.....	3
1.7 Impact of permanent structure on leisure/recreational users utilising Putney Slipway (draw dock)	3
1.8 Impact of project activities on special river events.....	4
1.9 Changes in flow	4
2 Site overview	5
2.1 Purpose of this report	5
2.2 Introduction.....	5
2.3 Limits of land to be acquired or used.....	6
2.4 Project phases.....	7
2.5 Construction methodology	7
2.6 Phase A: Construction of temporary/replacement slipway	7
2.7 Phase B: Temporary works construction	8
2.8 Phase C: Shaft, culvert and connections construction.....	8
2.9 Phase D: Cofferdam removal	8
2.10 Phase E: Permanent works site.....	9
2.11 Phase F: Removal of temporary/replacement slipway.....	9
3 Study aim and area	11
3.1 Introduction.....	11
3.2 General navigation	11
3.3 Bridges	12
3.4 The authorised channel	13
3.5 Tide set.....	14
3.6 Existing river users	14

4	Summary of navigational issues	19
4.1	Interaction with existing river traffic.....	19
4.2	Proximity to Putney Bridge	19
4.3	Impact on operators using Putney Pier.....	19
4.4	Putney Bridge arch closures.....	19
4.5	Impact and interaction on rowing community and other recreational users	20
4.6	CSO outfall	20
4.7	Impact of permanent structure on leisure users utilising Putney Slipway	21
4.8	Impact of project activities on one-off events.....	21
4.9	Increased flow affecting passing vessels.....	21
5	Stakeholder consultation	25
5.1	Consultation meetings	25
6	Risk assessment	27
6.1	Risk assessment: Methodology	27
6.2	Risk assessment: Criteria	28
6.3	Risk matrix.....	30
6.4	Hazard identification	31
6.5	Mitigation strategy	31
7	Navigational issues and mitigation measures.....	33
7.2	Interaction with existing river users.....	33
7.3	Proximity to Putney Bridge	38
7.4	Putney Bridge arch closures.....	40
7.5	Impact on operators using Putney Pier.....	43
7.6	Impact and CSO outfall location	44
7.7	Impact of permanent structure on leisure and recreational river users ..	45
7.8	Impact of project works on special river events	47
7.9	Relocation of moorings: Temporary slipway	48
8	General navigational hazards	51
8.2	Project phases A to D: Most likely	51
8.3	Project phases A to D: Worst case	54
9	Mitigation measures	59
9.1	Existing mitigation.....	59
9.2	Proposed mitigation.....	59
9.3	Design	60
9.4	Physical	61
9.5	River operations	61

10 Conclusion	63
10.1 Assessment.....	63
10.2 Stakeholder engagement.....	63
10.3 Risk analysis.....	63
10.4 Overall.....	65
11 Recommendations	67
11.1 General.....	67
Abbreviations	69
Glossary	71
Appendices	77
Annexes	79

List of figures

	Page number
Figure 2.1 CSO site structures (below-ground)	6
Figure 4.1 Proceeding upstream	20
Figure 4.2 Proceeding downstream.....	20
Figure 4.3 Temporary works: peak flood currents - large flood tide rise with 65 m ³ /s river flow	22
Figure 4.4 Permanent works: Peak flood currents - large flood tide rise with 65 m ³ /s river flow	23
Figure 6.1 The ALARP Principle.....	27
Figure 7.1 Rowers at Putney Pier.....	34
Figure 7.2 Turning to Surrey on an ebb tide at high tide.....	34
Figure 7.3 Turning to Surrey on an ebb tide at low tide	35
Figure 7.4 Turning to Surrey on an ebb tide	35
Figure 7.5 Proposed permanent structure and Putney Pier.....	36
Figure 7.6 Putney Bridge	39
Figure 7.7 Putney Bridge proceeding upstream	41
Figure 7.8 Putney Bridge proceeding downstream.....	41
Figure 7.9 Boom arrangement at Putney Embankment Foreshore	42
Figure 7.10 - Putney Pier.....	43
Figure 7.11 Location of permanent structure	46
Figure 7.12 Relocation of existing mooring: Temporary slipway.....	49
Figure 7.13 Alternative mooring locations	50

Figure 11.1 Potential marine logistics hierarchy 68

List of tables

	Page number
Table 3.1 Individual arch bridge clearances above Mean High Water Springs (Putney Bridge)	12
Table 3.2 Main arch No3 bridge clearance heights (Putney Bridge)	12
Table 3.3 Individual arch bridge clearances above Mean High Water Springs (Fulham Rail Bridge).....	12
Table 3.4 Main arch no3 bridge clearance heights (Fulham Rail Bridge)	12
Table 3.5 Individual arch bridge clearances at Mean High Water Springs (Westminster Bridge)	13
Table 3.6 Main arch No4 bridge clearance heights (Westminster Bridge).....	13
Table 3.7 Barn Elms: AM - upriver.....	14
Table 3.8 Barn Elms: AM - downriver	14
Table 3.9 Barn Elms: PM - upriver.....	15
Table 3.10 Barn Elms: PM - upriver.....	15
Table 6.1 Probability criteria	28
Table 6.2 Severity criteria: People.....	29
Table 6.3 Severity criteria: Environment.....	29
Table 6.4 Severity criteria: Operational impact.....	29
Table 6.5 Severity criteria: Media attention.....	29
Table 6.6 Risk assessment matrix.....	30
Table 6.7 Risk classification	30
Table 8.1 Most likely risk scores.....	51
Table 8.2 Worst credible risk scores.....	54
Table 9.1 Existing safeguards	59
Table 9.2 Mitigation measures within the project’s control	62
Table 10.1 Hazard overview: Most likely	64
Table 10.2 Hazard overview: Worst credible	64

Thames Tideway Tunnel
Thames Water Utilities Limited



Application for Development Consent

Application Reference Number: WWO10001

Navigational Issues and Preliminary Risk Assessment

Doc Ref: **7.20.01**

Putney Embankment Foreshore

Main Report

APFP Regulations 2009: Regulation **5(2)(q)**

Hard copy available in

Box **57** Folder **A**
January 2013

**Thames
Tideway Tunnel**



Creating a cleaner, healthier River Thames

This page is intentionally blank

1 Executive summary

1.1 Purpose

- 1.1.1 This report documents the activities and assessments undertaken to identify the navigational issues, risks and mitigation measures for the proposed permanent and temporary structures at the site known as Putney Embankment Foreshore as part of the Thames Tideway Tunnel project.
- 1.1.2 It was developed through liaison and consultation with Port of London Authority (PLA) and the other key stakeholders. It is intended to support the application for development consent and identify the navigational issues at the site and how these are to be managed. The process was used to inform the design of the permanent and temporary works and a number of measures to address navigational hazards have been embedded into the design.
- 1.1.3 The preliminary risk assessment follows the methodology proposed by the PLA rather than the methodology detailed within the PLA Safety Management System. The risk assessment reflects the level of development of the design in the application for development consent, that is, an outline design. The Contractor would be required to prepare detailed risk assessments and method statements and submit these to the PLA for approval before commencing any works in the river at this site.
- 1.1.4 The assessment was divided into six distinct project phases to assess hazards and develop risk reduction measures commensurate with the risk posed by different operations associated with the project. These phases are specific to this assessment and comprise:
- a. Phase A: construction of temporary/replacement slipway
 - b. Phase B: construction of cofferdam
 - c. Phase C: construction of shaft/culvert/connections
 - d. Phase D: removal of cofferdam
 - e. Phase E: permanent works site
 - f. Phase F: removal of temporary/replacement slipway.

1.2 Issues to be addressed

- 1.2.1 The proposed Putney Embankment Foreshore site lies between Putney Bridge and Putney Pier on the south bank of the River Thames in the Barn Elms Reach (Lower) area of the river (PLA Chart 312).
- 1.2.2 The proposed site encompasses an existing slipway, Putney Draw Dock, which is regularly used to launch and recover a variety of small/recreational craft. The project intends to construct a temporary slipway to the west of Putney Pier that would facilitate the launch and recovery of recreational craft in the absence of the Draw Dock facility. The temporary slipway would be constructed from prefabricated steel,

assembled on site and constructed prior to commencement of works at the main Putney Embankment Foreshore site.

1.2.3 The proposed work site lies in an area heavily used by the rowing and recreational river user community and the impact on leisure users is one of the main issues to be addressed within this report.

1.2.4 The other issues identified at this site are:

- a. interaction with existing river users
- b. proximity to Putney Bridge and bridge arch closures
- c. impact on operations at Putney Pier - for example Thames Clippers operations
- d. impact on vessels moored in the vicinity of the discharge outfall
- e. impact of the permanent structure on leisure users utilising Putney Draw Dock
- f. impact of Project activities on special river events, or example The Boat Race.

1.3 Interaction with existing river users

1.3.1 Comments provided during the public consultation periods by the user group most likely to be affected by the project works were taken into consideration during this assessment.

1.3.2 Observation of river traffic on this section of the Thames was conducted on a number of occasions, taking into consideration varying tidal and weather conditions.

1.3.3 During observations, large numbers of recreational craft, including small motorised leisure craft, kayaks, rigid inflatable boats, rowing boats and sailing boats were witnessed operating within the study area. In addition to the recreational craft, a number of commercial operations were also observed.

1.3.4 The movement of these vessels is unpredictable and due consideration is given to these vessels in the Navigational Issues and Risk Assessment.

1.4 Proximity to Putney Bridge and bridge arch closures

1.4.1 During construction and whilst the cofferdam is in place, it is expected that arch No5 would be closed to all vessels as the cofferdam would extend beneath this bridge arch.

1.4.2 This would not be expected to negatively impact on the majority of vessel operations in this area due to the limited available water and air draught under this arch.

1.5 Impact on operations at Putney Pier

- 1.5.1 Putney Pier is owned and operated by Livett's Launches. Use of the pier is by request, however bookings for private vessels as well as for charter and commercial craft are available.
- 1.5.2 It is understood that Transport for London and Thames Clippers have plans to extend the fast passenger service beyond St Georges Wharf to Putney Pier.
- 1.5.3 It would be during the project's construction Phases 2, 3 and 4 that the impact on Putney Pier operations would be likely to be experienced, due to construction activities and the movement of materials taking place in and around the study area.
- 1.5.4 Currently there are two residential house boats moored adjacent to the pier that may be affected by Project proposed works. It is likely that there would be a requirement to relocate at least one of the house boats during the project activities at this site.

1.6 Impact on vessels moored in vicinity of new discharge outfall

- 1.6.1 The initial design of the permanent structure at Putney Embankment Foreshore indicated that guardrails would be set back approximately 400mm from the structure's edge. The reasoning behind this was to provide footing for vessel operators berthing alongside the permanent structure.
- 1.6.2 The PLA has expressed concern that the Combined Sewer Overflow (CSO) discharge outfall which would be located at this site, of 5m³/s at 2m/s (4knots), could push a vessel from its mooring, stating that this arrangement would be unsatisfactory.
- 1.6.3 Although the probability of such a discharge was considered to be remote (not more than once in a typical year) it was agreed, within the project team, that this would present a potential navigational hazard and that due consideration should be given to the issue.

1.7 Impact of permanent structure on leisure/recreational users utilising Putney Slipway (draw dock)

- 1.7.1 On completion of the works at Putney Embankment Foreshore, the original draw dock would be reinstated in its original location and condition. The permanent structure would be at right angles to the draw dock, presenting a possible impact hazard to those using the slipway.
- 1.7.2 The proposed design was reviewed and additional impact protection/fendering arrangements are proposed.

- 1.7.3 The form of the permanent structure was also amended to incorporate a radius on the 'outside corners' to minimise the implications to both vessel and structure should a conflict occur.

1.8 Impact of project activities on special river events

- 1.8.1 This section of the Thames sees a number of high profile river events, most notably the Oxford versus Cambridge Boat Race and the Head of the River Races.
- 1.8.2 Project activities at this site would be likely to impact on these types of events, due to the movement of materials, construction activities and barge operations which would be likely to present navigational hazards to river users.
- 1.8.3 It is proposed that planned operating procedures and an intention to restrict the working hours at this site to Monday – Friday operations would greatly reduce the impact of project activities on special river events.

1.9 Changes in flow

- 1.9.1 Any intrusion into the river would change river flow. The analysis in this report considered the worst cases, combining the extreme fluvial and tidal flows. It was found that even in extreme cases the change in the **maximum** flow, for the most part, would reduce and would be limited to the area directly upstream and downstream of the temporary work structures. A slight increase (0.1 m/s) would be observed towards the centre of the river. This increase is small in extent and represents a small change compared to the baseline figure.

2 Site overview

2.1 Purpose of this report

2.1.1 The purpose of this report is to provide information on the navigational issues, risk assessment and mitigation measures associated with the proposed Albert Embankment Foreshore site. The report informs the *Transport Assessment and Environmental Statement* and the PLA approval process.

2.2 Introduction

2.2.1 The Thames Tideway Tunnel project (the 'project') comprises tunnels to store and transfer discharges from combined sewer overflows (CSOs) from West to East London for treatment at Beckton Sewage Treatment Works. The primary objective of the project is to control CSO discharges in order to meet the requirements of the EU Urban Waste Water Treatment Directive (91/271/EEC) (UWWTD) and the related UK Urban Waste Water Treatment Regulations.

2.2.2 The project comprises the following elements:

- a. a main tunnel from Acton Storm Tanks to Abbey Mills Pumping Station requiring five main tunnel sites (one of the sites would also intercept flows from one CSO)
- b. control of 18 CSOs by diverting intercepted flows into the main tunnel requiring 16 CSO sites; two long connection tunnels (Frogmore connection tunnel and Greenwich connect tunnel) and 11 short connection tunnels
- c. control of two CSOs by locally modifying the sewerage system requiring two system modification sites
- d. works to drain down the system at Beckton Sewage Treatment Works.

2.2.3 The main tunnel would connect to the Lee Tunnel at Abbey Mills Pumping Station. All the flows from the Thames Tideway Tunnel and the Lee Tunnel would be transferred to Beckton Sewage Treatment Works via the Lee Tunnel.

2.2.4 The Putney Embankment Foreshore CSO site would be required to intercept the Putney Bridge CSO, and to connect to the main tunnel. The proposed structures at this site are illustrated in Figure 2.1.

Figure 2.1 CSO site structures (below-ground)

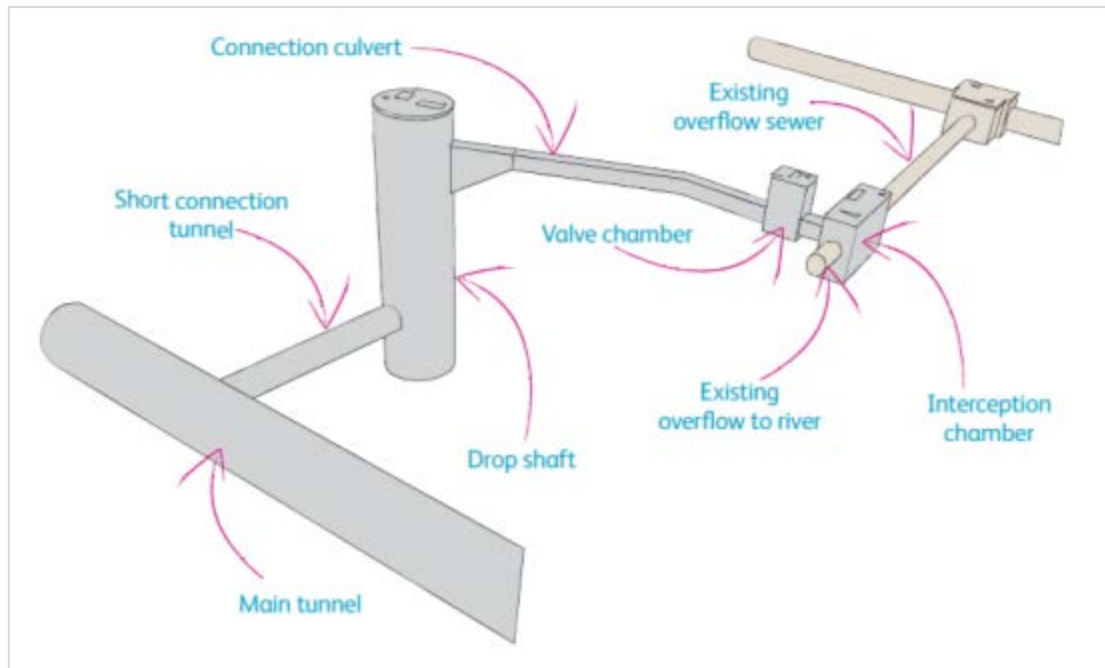

- 2.2.5 It is proposed that the permanent in-river structure at the Putney Embankment Foreshore site would accommodate:
- a CSO drop shaft – 6m internal diameter, approximately 36m deep
 - a connection to the Putney Bridge CSO outfall
 - connection culverts and valve chambers
 - air management structures
 - a new section of river wall.

- 2.2.6 A cofferdam would be constructed, which would include the following areas to enable construction of the permanent in-river structure:
- excavated material storage and handling facilities
 - cranes
 - maintenance workshop and storage
 - internal site roads
 - site support and welfare.

2.3 Limits of land to be acquired or used

- 2.3.1 The proposed draft limits of land to be acquired or used (LLAU) for this site extends from just downstream of Putney Bridge, through arch No4 and along to Putney Pier, a total of approximately 230m in length. Total maximum extension of the LLAU into the river from the foreshore is approximately 50m along most of its length. The LLAU does not encroach into the authorised channel, remaining at least 25m from it.

- 2.3.2 The LLAU encompasses the maximum working area required during construction. A cofferdam would be constructed within this area during the construction phases. The permanent river wall works would take place within the cofferdam.
- 2.3.3 The LLAU would be used intermittently, depending on the progress, method and phasing of construction.
- 2.3.4 Appendix A details the various design, construction and site layout drawings and show the LLAU.

2.4 Project phases

- 2.4.1 This assessment was divided into four distinct project construction phases to assess hazards and develop risk reduction measures commensurate with the risk posed by different operations associated with the project. These phases were identified for use during the navigation risk assessment and comprise:
 - a. Phase A: construction of temporary/replacement slipway
 - b. Phase B: construction of cofferdam
 - c. Phase C: construction of shaft/culvert/connections
 - d. Phase D: removal of cofferdam
 - e. Phase E: permanent works site
 - f. Phase F: removal of temporary/replacement slipway.

2.5 Construction methodology

- 2.5.1 All works would be undertaken in accordance with the project's *Code of Construction Practice (CoCP)*.
- 2.5.2 The code sets out a series of objectives and measures to protect the environment and limit disturbance from construction activities as far as reasonably practicable. The topics covered by the *COCP* include but are not limited to: working hours, traffic management, noise and vibration, air quality, waste management, recycling, ecology, archaeology and settlement.
- 2.5.3 The methodologies, layouts and plant requirements outlined in this document are for illustrative purposes only and may be varied by subsequent design and build construction contractors.

2.6 Phase A: Construction of temporary/replacement slipway

- 2.6.1 It is intended to provide a temporary slipway approximately 300m west of Putney Bridge to maintain river access whilst the existing slipway is unavailable to be used.

- 2.6.2 The temporary slipway would be a piled steel structure with the deck constructed from prefabricated steel, assembled on site and constructed prior to commencement of works at the main Putney Bridge site.
- 2.6.3 The construction would involve working from jack-up or spud leg barges or inter-tidal working. Initially, steel tubular piles for the slipway structure support and mooring points would be installed, followed by the deck formed from prefabricated steel being assembled on site.

2.7 Phase B: Temporary works construction

- 2.7.1 The cofferdam would be constructed by installing a sheet piled wall. It is currently envisaged that the cofferdam would be designed as a twin walled cofferdam to accommodate the various loading conditions including external tidal loading and internal plant/construction loading.
- 2.7.2 It is intended to use the river to access and service the cofferdam construction activities, and a jack-up or spud leg barge would be mobilised at the site. A jack-up barge is a hydraulically operated self-elevating platform, which provides a stable platform from which marine piling works can be undertaken. The barge would be equipped with a crawler crane for off-loading and pitching the sheets for the sheet piled wall, a silent piling hammer, a small welfare cabin, a rescue boat and generated power.

2.8 Phase C: Shaft, culvert and connections construction

- 2.8.1 The CSO drop shaft would be constructed by sprayed concrete lining or by precast segmental lining using caisson and underpinning. The connection tunnel would be constructed by sprayed concrete linings or by precast segmental lining using caisson and underpinning techniques and the interception chambers by traditional reinforced concrete structures.
- 2.8.2 An attendant excavator would load the excavation material into a dumper, which would deposit excavated material into the excavated material muck bin. A long reach excavator would load the excavated material into a barge moored alongside the cofferdam wall.

2.9 Phase D: Cofferdam removal

- 2.9.1 On completion of the CSO drop shaft and connection chambers, the permanent river wall would be constructed. The area between the cofferdam and permanent river wall would be excavated.
- 2.9.2 Concrete blinding would be installed and then the permanent river wall constructed.
- 2.9.3 Only once the permanent river wall is in place would the cofferdam on the riverside be removed in order to maintain flood protection. The cofferdam piled wall would then be dismantled by jack-up barge.

2.10 Phase E: Permanent works site

- 2.10.1 Once all temporary works structures have been removed and construction work is complete, a permanent in-river structure would remain at the site. Access to various elements of the site and underground works would be required for maintenance. River-based access during the permanent works phase would only be anticipated in the event of failure of the outer flap valves on the permanent river walls.
- 2.10.2 The permanent structure would extend approximately 15m into the river from the foreshore, would be approximately 35m wide and greater than 60m away from the authorised channel.

2.11 Phase F: Removal of temporary/replacement slipway

- 2.11.1 Once all temporary work structures have been removed, construction work is complete and the permanent in-river structure in place, the project would remove the temporary slipway.
- 2.11.2 All infrastructure associated with the temporary slipway would be removed.
- 2.11.3 Recreational and leisure users would have the use of the original draw dock which would be in its original location and retain its current form, alignment and width.

This page is intentionally left blank

3 Study aim and area

3.1 Introduction

- 3.1.1 The aim of this assessment is to identify and assess navigational hazards project-specific to construction activities at the Putney Embankment Foreshore and temporary slipway sites and to assess how the proposed phases of the project would likely impact on existing river users and river infrastructure.
- 3.1.2 This assessment considers all river users and the hazards that project activities could pose to navigation on the River Thames.
- 3.1.3 In compiling this assessment, the project undertook extensive consultation with the PLA and current river users, along with observations of current river operations.
- 3.1.4 In order to consider the navigation impact on the wider river community, the scope of this assessment comprised an area from Fulham Rail Bridge up river to the Putney Yacht Moorings. This study area captures the majority of vessel types likely to transit this section of the river and pass the worksite.
- 3.1.5 The proposed development site is in close proximity to Putney Pier, and the effects on traffic using Putney Pier were considered within this assessment.
- 3.1.6 The project proposes to use barges during Phase B - Cofferdam Construction and Phase D - Cofferdam Removal, to bring in and take away the material used to fill the cofferdam. The project also proposes to use barges for the removal of the excavated material associated with the shaft and connection tunnel construction during Phase C.
- 3.1.7 Opportunities to use barges during the construction of the temporary slipway (Phase A) also exist.

3.2 General navigation

- 3.2.1 The Putney Embankment Foreshore site is located within the Barn Elms Reach (Lower) section of the River Thames and is included in PLA Chart No 312.
- 3.2.2 Safety is the responsibility of all river users; however, overall responsibility for facilitating the safety of navigation on the River Thames rests with the PLA.
- 3.2.3 As part of its activities in maintaining navigational safety, the PLA produces Notices to Mariners (NTMs), which provide essential, up-to-date information and advice to those navigating within the Port of London. NTMs can range from information on special events, notifications of works (eg, the Network Rail works on Blackfriars Bridge), and notification of new and updated navigation rules and regulations. A full list of extant NTMs is available on the PLA website, <http://www.pla.co.uk/notice2mariners/index.cfm/site/navigation>.

3 Study aim and area

- 3.2.4 The River Thames becomes tidal downriver of Teddington Lock, with a tidal range of between five and seven metres at different locations.
- 3.2.5 On the flood tide, the tidal current flows up-river (ie, predominantly east to west) whereas on the ebb tide, the tidal current flows downriver (ie, predominantly west to east).

3.3 Bridges

- 3.3.1 Putney Bridge has five main arches, three of which are available for navigation; arches No2, 3 and 4 are designated as working arches. The work site is located partially under arch No5 of Putney Bridge.

Table 3.1 Individual arch bridge clearances above Mean High Water Springs (Putney Bridge)

Bridge Arch	1	2	3	4	5
Arch Clearance	3.4 m	4.4 m	5.3 m	4.4 m	3.5 m

Table 3.2 Main arch No3 bridge clearance heights (Putney Bridge)

Tide Set	Chart Datum	MHWN	MLWN	MLWS	HAT
Arch Clearance	11.2 m	6.4 m	10.8 m	11.1 m	4.8 m

- 3.3.2 Fulham Rail Bridge (also known as Putney Rail Bridge) has five main arches, three of which are available for navigation; arches No 2, 3 and 4 are designated as working arches.

Table 3.3 Individual arch bridge clearances above Mean High Water Springs (Fulham Rail Bridge)

Bridge Arch	1	2	3	4	5
Arch Clearance	6.3 m	6.5 m	6.8 m	7.1 m	7.3 m

Table 3.4 Main arch no3 bridge clearance heights (Fulham Rail Bridge)

Tide Set	Chart Datum	MHWN	MLWN	MLWS	HAT
Arch Clearance	12.8 m	8.0 m	12.3 m	12.7 m	6.3 m

- 3.3.3 The centre arch No3 is normally used by larger vessels, for inward and outward bound journeys.

3 Study aim and area

3.3.4 For reference, Westminster Bridge has the lowest available navigational arch clearance heights of the remaining bridges further downstream and therefore acts as a navigational restriction.

3.3.5 Westminster Bridge has seven main arches, all of which are available for navigation; arches No3, 4, 5 and 6 are designated as working arches.

Table 3.5 Individual arch bridge clearances at Mean High Water Springs (Westminster Bridge)

Bridge Arch	1	2	3	4	5	6	7
Arch Clearance	4.2 m	4.8 m	5.2 m	5.4 m	5.2 m	4.8 m	4.2 m

Table 3.6 Main arch No4 bridge clearance heights (Westminster Bridge)

Tide Set	Chart Datum	MHWN	MLWN	MLWS	HAT
Arch Clearance	12.2 m	6.5 m	11.1 m	11.8 m	4.8 m

3.4 The authorised channel

3.4.1 The authorised channel is marked on both Admiralty and PLA charts as a pair of dotted lines that define where the majority of commercial vessels generally navigate. However, vessels cannot always be expected to navigate 'within' the authorised channel.

3.4.2 The authorised channel in the Putney Bridge area varies between 55m and 65m wide and incorporates the working arches of the bridge.

3.4.3 The document General Directions for Navigation in the Port of London 2011 states the following:

"36. REQUIREMENT TO USE THE AUTHORISED CHANNEL

(1) This Direction applies only to vessels navigating between the Margaretness Limit and Putney Bridge.

"(2) Except in an emergency or for the purposes of overtaking, or with the permission of the Harbourmaster, or when manoeuvring to or from piers, wharves, anchorages or other berths, all Reporting Vessels and vessels of 13.7 metres or more in Length Overall shall normally navigate only in the authorised channel as identified on PLA charts.

"(3) Where there is sufficient room, vessels less than 13.7 metres in Length Overall should normally navigate outside the authorised channel unless constrained by their draught or otherwise restricted in ability to manoeuvre or in an emergency".

3.5 Tide set

- 3.5.1 During consultation for this and other sites associated with the project, the project determined that the ‘tide set’ in this area of the River Thames should be taken into consideration when assessing navigational hazards.
- 3.5.2 The term ‘tide set ’is used to describe the movement of water in a river into the bight or outside edge of a bend of a river. In a tidal river like the River Thames, which is embanked in the central area, it also leads to an increase in velocity.
- 3.5.3 Every vessel is affected by tide set in varying degrees. Smaller, faster-moving craft are affected less than larger, slow-moving vessels such as tugs and tows, which have to make course and steering adjustments to counteract the impact of tide set.
- 3.5.4 The embankments of the River Thames deflect the water flow towards the outside of the next bend. This effect manifests itself particularly in the section of the river that contains the various bridges.
- 3.5.5 The tide set in and around Putney Bridge is assessed as ‘Moderate South’ on both the flood and ebb tides.

3.6 Existing river users

- 3.6.1 In order for the project team to gain a greater understanding of typical vessels likely to be on the river within the study area and to aid the risk assessment process, vessel surveys were conducted.
- 3.6.2 Table 3.7 to Table 3.10 provide sample data from the river use survey.

Table 3.7 Barn Elms: AM - upriver

Vessel class / time	07.30	08.00	09.00	10.00	11.00	12.00
	- 08.00	- 09.00	- 10.00	- 11.00	- 12.00	- 12.30
Rowing 2-4	22	12	17	19	49	1
Rowing 4-8	6	10	8	9	23	1
Inflatable, motorised	4	9	8	8	15	2
Motorised cruiser	0	0	0	0	0	2
Tug	0	0	0	0	1	0

Table 3.8 Barn Elms: AM - downriver

Vessel class / time	07.30	08.00	09.00	10.00	11.00	12.00-12.30
	- 08.00	- 09.00	- 10.00	- 11.00	- 12.00	
Rowing 2-4	6	23	37	16	33	15
Rowing 4-8	0	9	13	5	24	0
Inflatable, motorised	0	6	10	3	18	6
Tug	0	0	1	0	0	0

Table 3.9 Barn Elms: PM - upriver

Vessel class / time	13.00 - 14.00	14.00 - 15.00	15.00 - 16.00	17.00 - 18.00
Rowing 2-4	1	16	18	5
Rowing 4-8	0	4	5	3
Inflatable, motorised	1	9	8	4
Police vessel	0	0	0	0

Table 3.10 Barn Elms: PM - upriver

Vessel class / time	13.00 - 14.00	14.00 - 15.00	15.00 - 16.00	17.00 - 18.00
Rowing 2-4	1	6	24	7
Rowing 4-8	0	5	2	6
Inflatable, motorised	0	6	8	9
Police vessel	1	0	0	0

- 3.6.3 The PLA provide practical advice and guidance for recreational river users, including:
- a. *Primarily at weekends, large numbers of recreational craft manoeuvre above Putney Bridge. Motor vessels must therefore observe the 8 knot speed limit at all times and pay special attention to their wash. If you are navigating an unpowered craft, you must be familiar with the code of practice for paddle powered vessels which is on the PLA website - www.boatingonthethames.co.uk*
- 3.6.4 Putney Pier is located close to the proposed CSO foreshore site and offers a commuter passenger service to Blackfriars operated by Complete Pleasure Boats, from Monday – Friday during morning and evening peak hours only.
- 3.6.5 The project understands that Transport for London is investigating the feasibility of extending the current Thames Clipper fast passenger service to Putney Pier. It is anticipated that this service will commence in late 2012.
- 3.6.6 Putney Pier is owned and operated by Livett's Launches. Use of the pier is strictly by request however bookings for private vessels as well as for charter and commercial craft are available.
- Putney draw dock**
- 3.6.7 Putney draw dock is used by a variety of river users, predominately by recreational users for the launch and recovery of vessels and a number of commercial operations.
- 3.6.8 The draw dock is used frequently by Chas Newens Marine, sailing clubs and independent leisure users.
- 3.6.9 Thames Executive Charters currently use the draw dock on a weekly basis. Each Wednesday, stores and provisions are delivered to the draw dock to be loaded on to barges. Once loaded, the barge distributes stores

to Thames Executive Charter vessels and other boat service operators. Fortnightly, fuel is pumped onto barges.

- 3.6.10 Deliveries are limited to three and a half hours due to tide levels, between the period commencing two hours prior to high tide and finishing one and a half hours after high tide.
- 3.6.11 There is a very high risk of vessel grounding outside of this window.
- 3.6.12 Thames Executive Charters currently use a 40t (35m x 6m with a 1.5m draft) motorised 'Dutch Barge', fitted with an onboard crane and internal fuel tanks to conduct the services detailed above¹. The company has indicated in discussions an intention to increase the number of supply vessels within their fleet with a corresponding increase in the frequency of deliveries.

Sailing clubs

- 3.6.13 Sailing activities take place on most days within the study area.
- 3.6.14 Race programmes take place almost every weekend during the summer and winter, and on some summer evenings, dependant on the tide and weather conditions.
- 3.6.15 Sailing clubs within the study area include the following:
- 3.6.16 Ranelagh Sailing Club (www.ranelagh-sc.co.uk) who:
 - a. are located at the Club house - The Embankment, Putney
 - b. partake in year round sailing in Putney
 - c. have a schedule of club events which can be found at <http://www.ranelagh-sc.co.uk/raschedule.htm>
 - i the majority of events take place on Saturdays and Sundays
 - ii occasional events take place on weekdays
 - iii the tidal cycle and the need to sail in daylight mean that there are between 72 and 90 races each year
 - iv training is provided during the summer months mid-week on the water when tide conditions allow.
- 3.6.17 South Bank Sailing Club(www.southbanksailingclub.co.uk) who:
 - a. are located at The Towpath, Embankment, Putney, London SW15 1LB
 - b. partake in year round sailing in Putney.
- 3.6.18 Hurlingham Yacht Club (website unavailable) who:
 - a. are located at 43A Deodar Road, London, SW15 2NP.

Rowing clubs

- 3.6.19 There are a large number of rowing clubs on the Thames, with the most popular area to row being above Putney. Due to the large number of

¹ Information provided by Thames Executive Charters.

rowers and the interaction with other recreational users, the PLA have set special rules to make rowing safer along the river above Putney.

- 3.6.20 In 2009 the Port of London Authority and the Thames Regional Rowing Council (TRRC) issued '*A code of practice for rowing on the tidal Thames above Putney*'. This document provides practical guidance from experienced rowers, recommendations from an external risk assessment, and the requirements of local and international regulations.
- 3.6.21 Its objective is to provide the rowing community with a single comprehensive source of information and advice about rowing on the tidal River Thames, in which all may have confidence, and which would enhance safety.
- 3.6.22 The TRRC state that there are fourteen rowing clubs which would be directly affected by the proposed Project works at Putney, with other clubs further along the river also likely to be affected as they also use the Putney Reach area. The Rowing Clubs within the study area include:
- 3.6.23 London Rowing Club (www.londonrc.org.uk):
- a. located at Putney Embankment, London, SW15 1LB
- 3.6.24 Thames Rowing Club (www.thamesrc.co.uk):
- a. located at Putney Embankment, London, SW15 1LB
- 3.6.25 Vesta Rowing Club (www.vestarowing.co.uk):
- a. located at Putney Embankment, London, SW15 1LB

This page is intentionally left blank

4 Summary of navigational issues

4.1 Interaction with existing river traffic

- 4.1.1 This section of the river is heavily used by recreational river users, several passenger and commuter services and by a large rowing community.
- 4.1.2 The interaction of project operations with existing river traffic, including vessels using Putney Pier, in transit past the site and at the temporary slipway has been identified as a potential navigational hazard at this site.

4.2 Proximity to Putney Bridge

- 4.2.1 Putney Bridge has five arches and arches No 2, 3 and 4 are designated as working arches in the PLA's *Mariners Guide to Bridges on the Tidal Thames*. Arch No2 is normally used by vessels heading upstream and arch No4 by vessels that are heading downstream, subject to the height of the tide. Arch No3 is for two-way traffic when the tide does not allow arches No2 and 4 to be used.
- 4.2.2 While the temporary cofferdam is in place, it is expected that arch No5 would be closed to all vessels because the cofferdam would extend beneath the bridge arch. This is not expected to affect the majority of vessel operations in this area because the arch is not frequently used due to the limited available water and air drafts.

4.3 Impact on operators using Putney Pier

- 4.3.1 Putney Pier is owned and operated by Livett's Launches. Use of the pier is strictly by request however bookings for private vessels as well as for charter and commercial craft are available.
- 4.3.2 A Monday to Friday service from Putney Pier to Blackfriars Pier is operated during peak hours by Complete Pleasure Boats (as detailed on the TfL website).
- 4.3.3 The impact on operations at Putney Pier as a result of the proposed works at Putney Embankment Foreshore is assessed as a key marine issue within this report.

4.4 Putney Bridge arch closures

- 4.4.1 While the cofferdam is in place it is expected that arch No5 would be closed to all vessels as the cofferdam would extend beneath the bridge arch and there would be construction plant located in the river.
- 4.4.2 Closure of arch No4 may be required during some construction activities.

Figure 4.1 Proceeding upstream

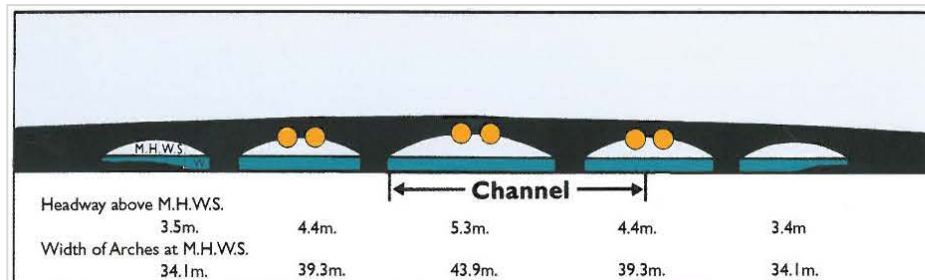
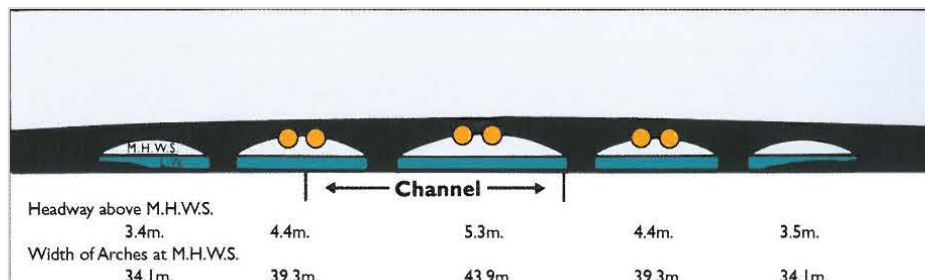

Figure 4.2 Proceeding downstream



4.4.3 The requirement to close arch No4 has been identified as a potential navigational hazard at the Putney Embankment Foreshore site.

4.5 Impact and interaction on rowing community and other recreational users

4.5.1 The impact on, and the interaction with, the rowing community and other recreational river users at both the main works site and at the relocated slipway has been identified as a potential navigational hazard at the Putney Embankment Foreshore site.

4.5.2 The Barn Elms Reach section of the river Thames is heavily used by rowers with 25 clubs, universities and schools listed by the Thames Regional Rowing Council (TRRC) for the Putney section alone.

4.5.3 The existing slipway, situated between Putney Pier and Putney Bridge, would not be available for public use during the construction phase of the project. A temporary replacement slipway would be provided upstream of Putney Pier, to allow for rowers and recreational river users to launch/recover vessels in the Putney area away from the construction site.

4.6 CSO outfall

4.6.1 Both the PLA and Hurlingham Yacht Club expressed a wish to be able to moor alongside the proposed new structure at Putney Foreshore.

4.6.2 An early design of the permanent structure had guardrails set back approximately 400mm from the structure's edge to provide footing for vessel operators berthing alongside the permanent structure.

- 4.6.3 Subsequently the PLA expressed concern that the CSO discharge outfall located at this site of 5m³/s at 2m/s (4knots) could push a vessel from its mooring, stating that this arrangement was unsatisfactory.
- 4.6.4 Although the probability of such a discharge would be low (approximately once in a typical year) it was agreed that this did present a potential navigational hazard.
- 4.6.5 The configuration of the CSO discharge outlets was modified to minimise the anticipated discharge velocities. The design of the permanent foreshore structure was also amended to provide a 'lay-by' mooring facility on the upstream end, with mooring prohibited on the downstream end adjacent to the relocated CSO outlets. Navigational aids including fenders have been provided on the upstream end to facilitate mooring.

4.7 Impact of permanent structure on leisure users utilising Putney Slipway

- 4.7.1 On completion of the works at Putney Embankment Foreshore, the original draw dock would be reinstated in its original location and alignment. The permanent structure would be at right angles to the draw dock, presenting a possible hazard to those using the slipway.
- 4.7.2 The slipway is used by river users to launch and recover a variety of recreational craft with a wide range of experience and river knowledge. The proposed design was reviewed and additional impact protection and fendering arrangements were included.
- 4.7.3 During consultation with a number of local river users it was highlighted that the new layout of the slipway may locally alter the tidal patterns meaning boats may behave unexpectedly during launch and recover operations. This has been identified as a potential navigational hazard at the Putney Embankment Foreshore site.

4.8 Impact of project activities on one-off events

- 4.8.1 This section of the tidal Thames sees a number of high profile river events, most notably the Oxford to Cambridge Boat Race and the Head of the River Races.
- 4.8.2 Project activities at this site have the potential to affect these events, with the movement of materials, construction activities and barge operations likely to present a navigational hazard to river users.
- 4.8.3 The Code of Construction Practice limits most operations at this site to standard working hours (8am to 6pm Monday to Friday and 8am to 1pm on Saturdays). It also requires the that Contactor suspend works during special river events.

4.9 Increased flow affecting passing vessels

- 4.9.1 The increase in river speed due to the temporary cofferdam and permanent structure may affect passing river traffic with certain vessel

types expected to be affected more than others. The rowing community and users of smaller recreational craft are likely to be most affected by changes to river speed in this area.

- 4.9.2 Detailed analysis of fluvial modelling studies carried out by HR Wallingford was conducted. Given the limited change in flow expected at the site, the results of this analysis are presented within the body of this report, rather than in a separate annex.
- 4.9.3 A summary of the main change in flow is presented below. Both images are based on modelling work carried out by HR Wallingford and represent the predicted change in flow near to the site caused by the temporary and permanent works for a large flood tide rise with $65\text{m}^3/\text{s}$ river flow. This tidal condition is one of the worst case scenarios and thus the image shows one of the greatest potential changes to flow in the area.
- 4.9.4 The images show that the river speed, for the most part, would decrease and changes would be limited to the area directly upstream and downstream of the temporary work structures. A slight increase (0.10 m/s) can be observed towards the centre of the river. This increase is localised in extent and represents a small change compared to the baseline. It is also further out into the river than would generally be used by rowers and small recreational craft.

Figure 4.3 Temporary works: peak flood currents - large flood tide rise with $65\text{ m}^3/\text{s}$ river flow

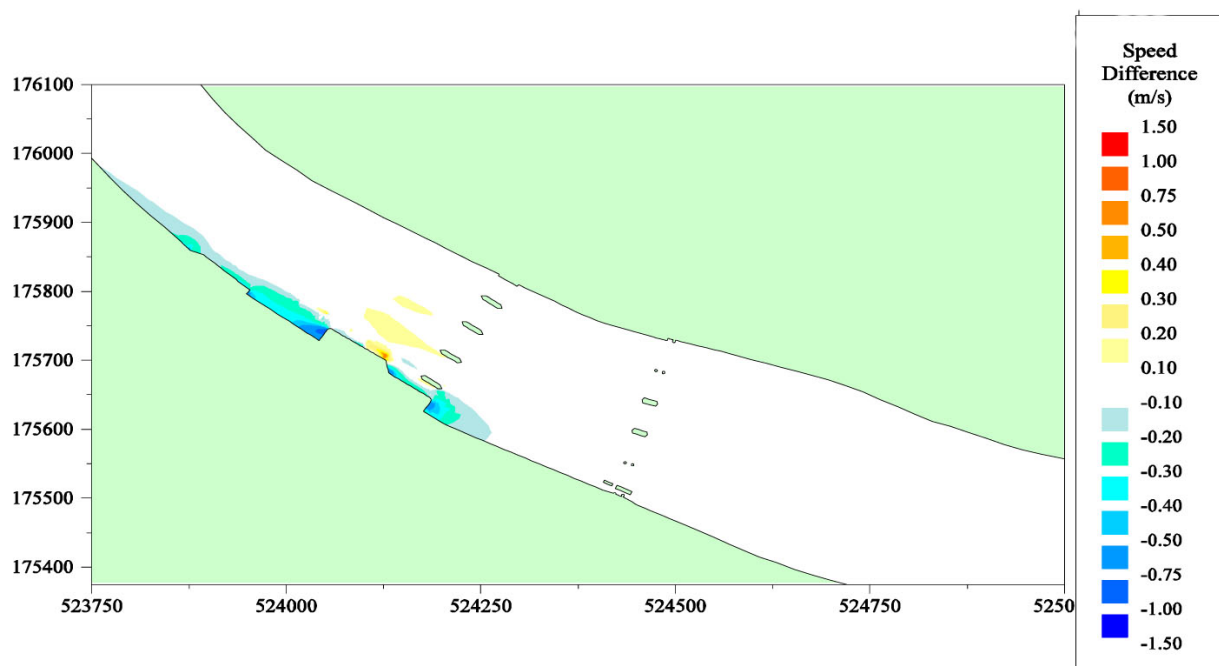
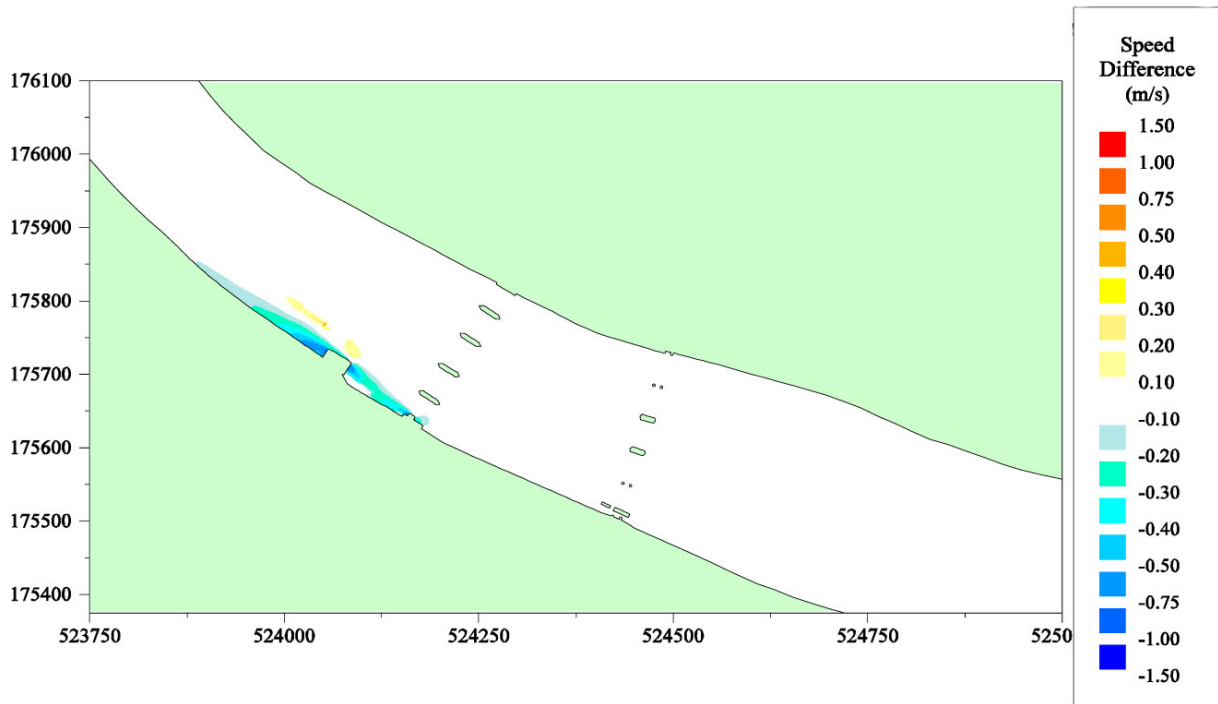

Figure 4.4 Permanent works: Peak flood currents - large flood tide rise with 65 m³/s river flow



This page is intentionally left blank

5 Stakeholder consultation

5.1 Consultation meetings

- 5.1.1 During public consultation and throughout the design phases of the project, the project team has engaged with local stakeholders.
- 5.1.2 For the site at Putney Bridge consultation has been undertaken with a number of organisations including:
 - a. Adrian Allworth, Thames Executive Charters
 - b. Chris Livett, Livett's Launches
 - c. Chas and Julie Newens, Chas Newens Marine
 - d. Alex Brown, Port of London Authority
 - e. Terry Lawrence, Port of London Authority.
- 5.1.3 The consultation continues regarding a number of topics.

This page is intentionally left blank

6 Risk assessment

6.1 Risk assessment: Methodology

- 6.1.1 For each of the identified hazards, the associated risk was assessed and classified. The following definitions were applied for the purposes of this report:
- Hazard: eg, an object, activity or phenomenon that can cause an adverse effect.
 - Risk: a relative measure of harm or loss, derived from the combination of the severity of a particular consequence together with the probability of the consequence occurring.
 - Consequence: a particular scenario (expressed as harm to people, damage to the environment, an operational impact and/or negative media attention) that results from a hazardous situation.
 - Probability: the chance of a particular hazard consequence occurring, measured as a frequency (per year).
- 6.1.2 The assessment used the principle of reducing navigational risks to a level that is As Low As Reasonably Practicable (ALARP). ALARP is part of the Health and Safety at Work Act 1974 and involves assessing the acceptability of a risk against the difficulty, time and expense needed to control it. The ALARP concept is illustrated in Figure 6.1.

Figure 6.1 The ALARP Principle

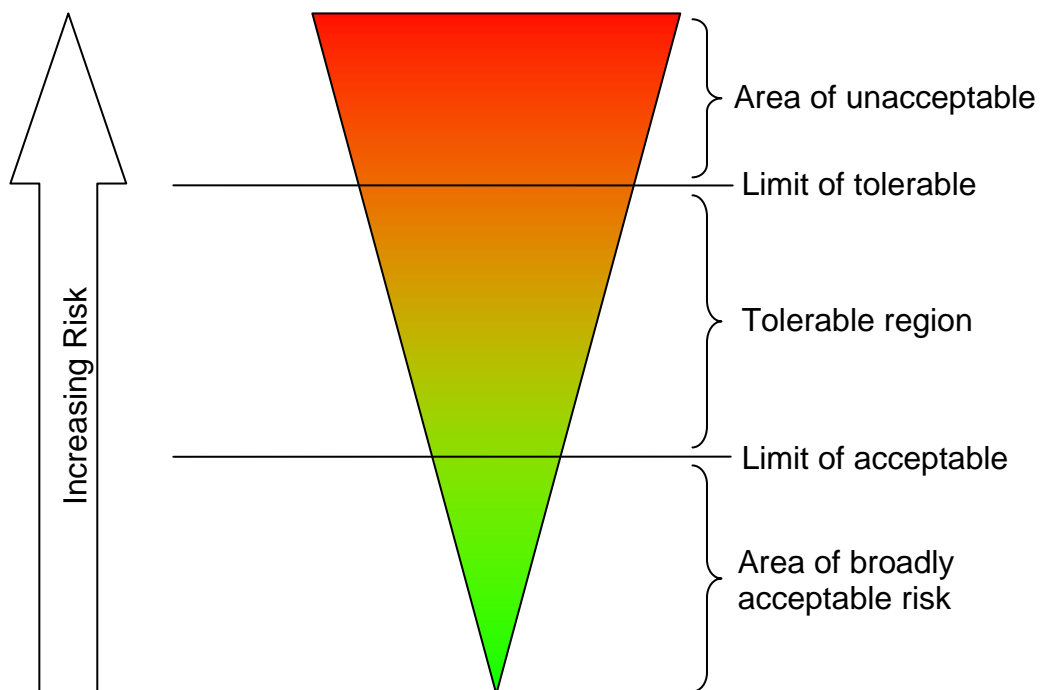

- 6.1.3 At the lower end of the ALARP triangle, risks are small due to either low probability or insignificant consequences. These risks can generally be accepted provided that common safeguards are implemented. Moving up the ALARP triangle to the tolerable region, risks increase in magnitude

due to either an increase in probability or an increase in severity of consequences. Risks in the tolerable region can be accepted provided that risk controls are implemented that demonstrate that the risk is reduced to a level deemed to be ALARP; where any further risk reduction would be disproportionate in terms of cost, time and resources required to implement it compared to the benefit it would introduce. At the top of the ALARP triangle is a region of unacceptable risk that cannot be accepted without risk controls to reduce the risk to a tolerable and ALARP level.

6.1.4 This risk assessment was undertaken on a qualitative basis, using the engineering and operational judgement of representatives from the project team including representatives from river users and operators. Hazard consequences contained within each of the hazard logs consider most likely and worst credible outcomes.

6.2 Risk assessment: Criteria

6.2.1 When commencing the assessment of the risk posed by the project’s activities, the project’s marine consultant recommended using the risk assessment criteria and methodology within the existing PLA Safety Management System (SMS). The rationale behind this recommendation was to provide the project team and the PLA with a consistent assessment score that could be transferred across into the PLA’s existing SMS and enable an appreciation of the increase in risk resulting from the project’s temporary and permanent works.

6.2.2 Consultation with the PLA highlighted the PLA’s desire to use a project specific risk terminology, as well as an alternative assessment matrix and risk classification scorecard. These changes have been incorporated.

6.2.3 This section details the risk criteria used throughout this assessment. The assessment process identifies four distinct areas of risk and the probable consequences associated with each hazard assessed in terms of harm or loss to:

- a. people (life)
- b. environment
- c. operational impact
- d. media attention.

6.2.4 Table 6.1 details the ‘probability’ criteria used to assess how likely each hazard is to occur in terms of average frequency in the PLAs jurisdiction.

Table 6.1 Probability criteria

	Frequency	Score
Rare	Has not occurred in the in the last ten years	1
Unlikely	Has not occurred in the in the last three years	2
Possible	Has not occurred in the in the last year	3
Likely	Has occurred in the in the last year	4
Almost certain	Occurs several times per year	5

- 6.2.5 Table 6.2 details the severity criteria applied to the safety- related consequences of each hazard.

Table 6.2 Severity criteria: People	Level
First aid case / Medical treatment case	1
Restricted work case	2
Lost Time Injury / Moderate permanent partial disability injury	3
Single Fatality / Severe permanent partial disability	4
Multiple fatalities	5

- 6.2.6 Table 6.3 details the severity criteria applied to the environmental loss related consequences of each hazard.

Table 6.3 Severity criteria: Environment	Level
Low impact with no lasting effect	1
Temporary effect / Minor effect to small area	2
Short to medium term impact	3
Medium to long term effect / large area affected	4
Long term impact / severe impact on sensitive area	5

- 6.2.7 Table 6.4 details the severity criteria applied to the property loss/damage related consequences of each hazard.

Table 6.4 Severity criteria: Operational impact	Level
Insignificant or no damage to vessel / equipment	1
Minor or superficial damage to vessel / equipment	2
Moderate damage to vessel / equipment requiring immediate repairs	3
Major damage to vessel / equipment and detention	4
Very serious damage to vessel or equipment possible criminal proceedings	5

- 6.2.8 Table 6.5 details the severity criteria applied to negative media attention/coverage consequences of each hazard.

Table 6.5 Severity criteria: Media attention	Level
No Coverage	1
Local coverage	2
Regional coverage	3
National coverage	4
International coverage	5

6.3 Risk matrix

- 6.3.1 The risk matrix in Table 6.6 was used to provide a risk score, combining severity of a particular consequence with the likelihood (probability) of the consequence occurring.

Table 6.6 Risk assessment matrix

Likelihood	Rare	1	2	3	4	5
	Unlikely	2	4	6	8	10
	Possible	3	6	9	12	15
	Likely	4	8	12	16	20
	Almost certain	5	10	15	20	25
	Severity	Level 1	Level 2	Level 3	Level 4	Level 5

- 6.3.2 The risk score in Table 6.7 indicates the magnitude and acceptability of the risk in accordance with the ALARP principle. The PLA method applies this to both individual and average risk.

Table 6.7 Risk classification

Score	Classification	Definition
1 to 2	Slight	No action is required.
3 to 4	Minor	No additional controls are required, monitoring is required to ensure no changes in circumstances.
5 to 9	Moderate	Efforts should be made to reduce risk to ALARP level. Job can be performed under direct supervision of Senior Officer.
10 to 14	High	Efforts should be made to reduce risk to ALARP level. Job can only be performed after authorisation from Harbour Master and after further additional controls required under the circumstances.
15 to 25	Extreme	Intolerable risk. Job is not authorised.

6.4 Hazard identification

- 6.4.1 A hazard can be defined as ‘the potential for an adverse consequence’, and may be associated with a situation that could cause harm to people, damage to the environment, an operational impact or negative media attention.
- 6.4.2 In order to facilitate a comprehensive overview of potential maritime hazards, various river users and operators were consulted throughout the risk assessment process, including:
- a. Thames Clippers;
 - b. Cory Environmental Limited;
 - c. City Cruises;
 - d. Livett’s Launches;
 - e. Bennett’s Barges;
 - f. London Duck Tours;
 - g. Metropolitan Police Marine Policing Unit;
 - h. Royal National Lifeboat Institute (RNLI).
- 6.4.3 The project also made several site visits to HR Wallingford’s physical model during the risk assessment process. This provided Captain David Phillips (at the time, PLA Harbour Master (Upper)), freight (Cory Environmental) and commercial (Thames Clippers) operators with the opportunity to understand the impact of the proposed developments on the river flow patterns and to visualise the scale of the temporary and permanent work at various locations. However, the site at Putney Embankment Foreshore was not included in this physical model.

6.5 Mitigation strategy

- 6.5.1 Throughout the assessment process, it was evident that potential hazards presented by the project would require mitigation measures throughout the project lifecycle.
- 6.5.2 The following section will identify and detail the navigational issues and proposed mitigation measures.

This page is intentionally left blank

7 Navigational issues and mitigation measures

- 7.1.1 It is acknowledged that mitigation measures may themselves introduce further hazards that also require mitigation. Where appropriate, these have been considered.
- 7.1.2 Mitigation measures were developed with an emphasis on measures that are within the project's control (e.g. design of in-river structures).
- 7.1.3 For the purpose of this assessment, mitigation measures (risk control options) were classified as three types;
- a. Design: measures that can be implemented by the project at the design stage.
 - b. Physical: measures that the project can implement during the construction and operational phases.
 - c. Operational: measures that the project can implement in conjunction with the PLA at all stages of the project.
- 7.1.4 Of course, some proposed mitigation measures would be beyond the project's control, such as emergency plans and operating procedures.

7.2 Interaction with existing river users

- 7.2.1 This section of the river is heavily used by recreational river users, several passenger/commuter services, commercial operations and by a large rowing community.
- 7.2.2 Putney Pier, owned and operated by Livett's Launches, is located approximately 20m from the western end of the proposed cofferdam. Use of the pier is strictly by request however bookings for private vessels as well as for charter and commercial craft are available.
- 7.2.3 A Monday to Friday passenger service operates from Putney Pier to Blackfriars Pier during peak hours and is run by Complete Pleasure Boats (as detailed on TfL website). The project understands that TfL have plans to extend the current Thames Clipper passenger service to Putney Pier.
- 7.2.4 The Thames Regional Rowing Council (TRRC) divide the river up into ten separate areas, with 25 clubs, universities and colleges, and schools listed in the Putney area (Division 19).

Figure 7.1 Rowers at Putney Pier



7.2.5 The PLA, in conjunction with the TRRC, have produced the Code of Practice for Rowing on the Tideway. The code was revised in 2009 and contains practical guidance and aims to provide the rowing community with a single comprehensive source of information and advice about rowing on the tidal Thames.

7.2.6 Putney Bridge is designated as a crossing zone with the following advice to rowers given:

- a. Turning to Surrey on the ebb tide at Putney Pier - High Tide:
 - i The route normally taken by boats, with the danger of being swept onto Putney Pier.
 - ii If there is enough water under the Surrey arch of Putney Bridge and behind Putney Pier, this is the safest route.

Figure 7.2 Turning to Surrey on an ebb tide at high tide

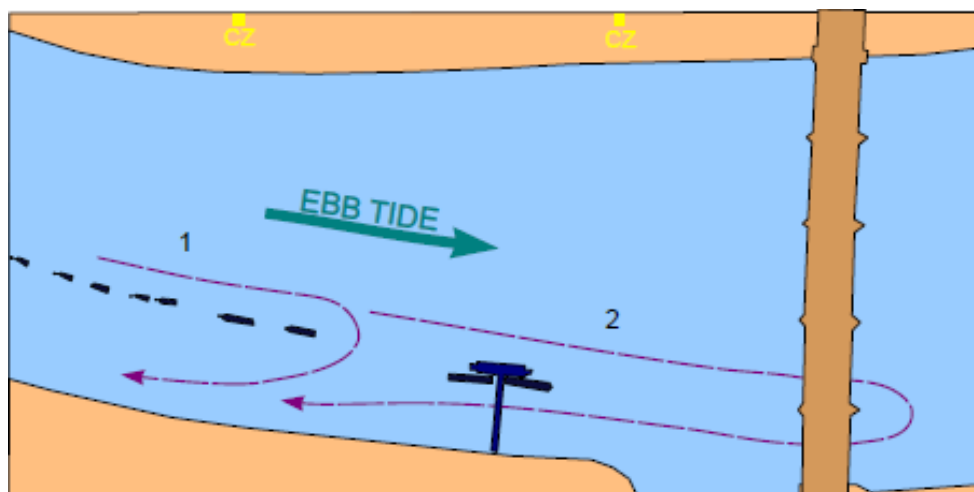

- b. Turning to Surrey on the ebb tide at Putney Pier - Low Tide
 - i The route normally taken by boats, with the danger of being swept onto Putney Pier.
 - ii If a crew cannot take route 1, this is the route that must be used. Care must be taken when crossing the river.

Figure 7.3 Turning to Surrey on an ebb tide at low tide

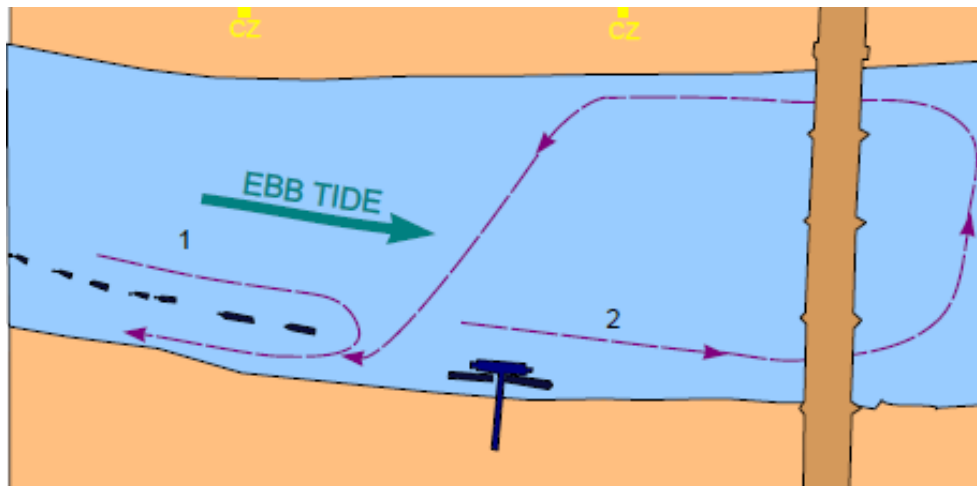

c. Turning to Surrey on the ebb tide at Putney Pier

i This route is not to be undertaken under any circumstances

Figure 7.4 Turning to Surrey on an ebb tide

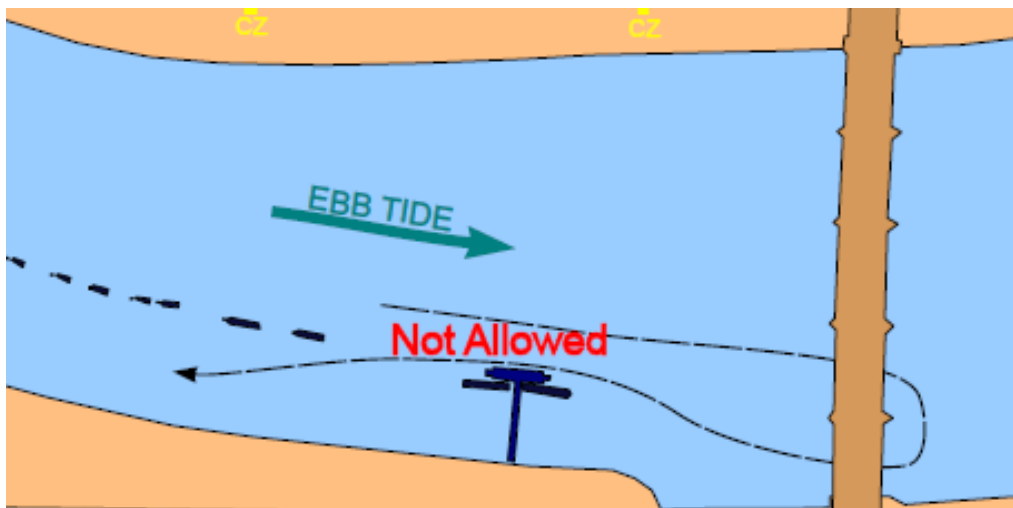

7.2.7 The diagrams above provide an indication of the level of interaction likely to be experienced at this site and highlights the need to maintain consultation with the TRRC.

7.2.8 The distance between the downstream face of Putney Pier to the upstream face of the proposed permanent structure is approximately 30m. This distance would be reduced if a vessel is moored on the inner face of the Pier. 30m may be a sufficient separation distance for rowers to execute the manoeuvre however consultation with TRRC is required to confirm this.

Figure 7.5 Proposed permanent structure and Putney Pier

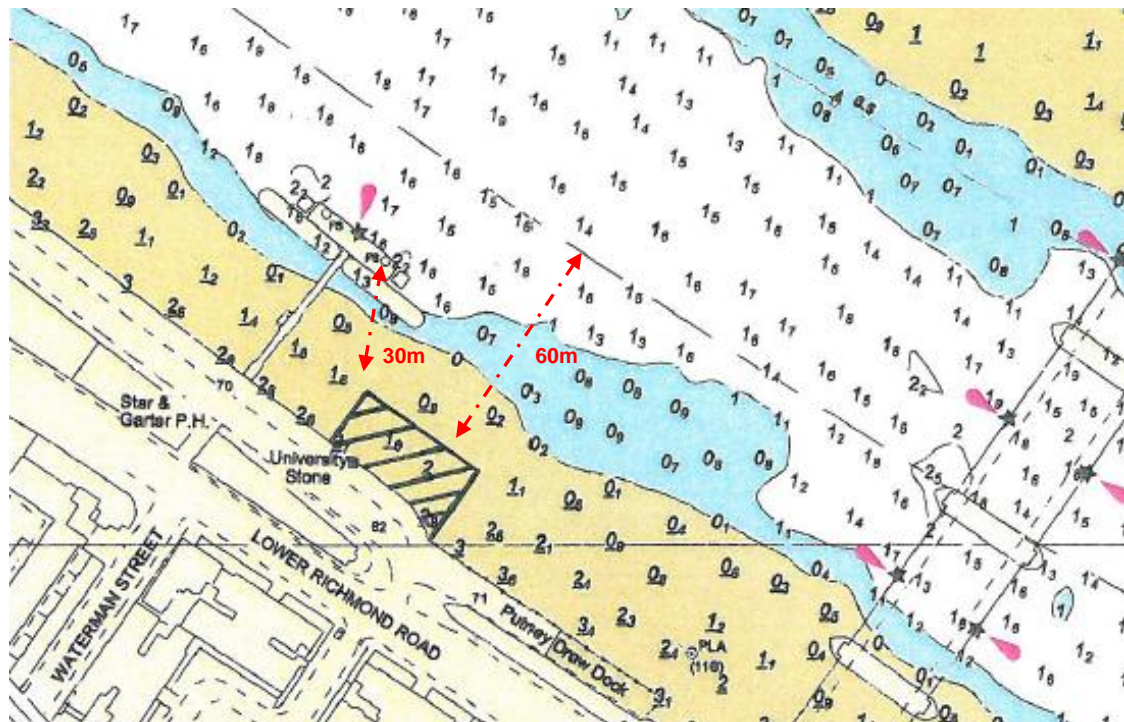

- 7.2.9 An alternative turning zone would need to be identified and published for turning to Surrey on an ebb tide at high tide, taking into consideration the extent of the project works.
- 7.2.10 The PLA's publication *A Mariners Guide to Bridges on the Tidal Thames* indicates that the presence of rowing and sculling craft is very much in evidence in Barn Elms Reach and vessels should proceed with extreme caution.
- 7.2.11 Sailing also takes place on this stretch of the river with several sailing clubs having their clubhouse along The Embankment at Putney.
- 7.2.12 The current slipway, listed on PLA charts as Putney draw dock, is used by a variety of users:
- a. recreational users - launch and recovery of powered and self-powered craft
 - b. commercial operators - launch and recovery of smaller powered craft
 - c. vehicle access is available to the draw dock providing users with the facility to take larger trailers/boats down the slipway.
- 7.2.13 One commercial operator in this area is Chas Newens Marine. This company provides services to the river user community on this section of the river, including:
- a. maintenance of boats
 - b. moorings
 - c. rescue and umpire boats for major events.

- 7.2.14 In addition to the slipway adjacent to their property, Chas Newens Marine uses the existing Putney draw dock to launch and recover vessels.

Actions required

- 7.2.15 A number of actions, specific to the issue, have been commenced or completed in order to assist the project to provide a robust and evidence-based assessment to the PLA. These actions include:
- conduct analysis of recreational traffic operating in this section of the river
 - identify typical river traffic that uses this section of the river and its frequency
 - observe and record leisure/recreational river traffic in area: vessels under 13.7m navigating outside of the authorised channel
 - review observation data collated by Peter Brett Associates and Arup undertaken as part of a comparative study with Carnwath Road Riverside

Mitigation of issues: Design

- 7.2.16 Designing the project has been an iterative process, influenced by the ongoing navigational risk assessment process. Measures to eliminate or reduce navigational hazards identified in early risk assessments were embedded into the design of the temporary and permanent works to eliminate or reduce navigational hazards. This assessment therefore assesses the residual risk assuming the effective implementation of these measures. The embedded measures include:
- The design and in-river footprint of the temporary and permanent works site was minimised so that intrusion into the river is minimal and set back from the authorised channel.
 - A temporary slipway would be constructed upstream of Putney Pier and would remain in place for the duration of the construction period (i.e. while Putney draw dock is unavailable).
 - The permanent works design includes fendering and takes into consideration PLA's concerns regarding potential impact hazards including striking the downstream face. The design incorporates continuous timber fendering and a radius to the 'outside corners' of the structure to minimise any impacts to both structure and vessel, should a collision occur.
 - The design of the permanent structure discourages vessels from mooring adjacent to the CSO outfall, but permits mooring along the remaining sections of the river wall.
 - A lay-by mooring facility would be provided on the upstream end of the permanent structure, away from the CSO outfall. This means that the hand railings would be set back from the edge of the structure to enable users to temporarily step off vessels. Access gates within the handrail would not be provided to discourage long-term mooring. Two mooring bollards would be provided adjacent to the lay-by mooring

area. Timber piled fenders would be provided at the lay-by mooring location.

- f. Timber piled fenders are required along the river face adjacent to the CSO outlets to ensure that the flap valves are not prevented from opening as a result of a moored vessel.

7.2.17 The following sections set out the proposed mitigation measures to address the residual risks.

Mitigation of issues: Physical

- a. consultation with TRRC, Putney Pier owner and recreational river users to get their views and input into interaction issues and possible working relationships
- b. restrict project river operations at this site to Monday to Friday only. River operations should not take place on Saturdays when river use is traditionally higher.

Mitigation of issues: River operations

- a. Issue Notice to Mariners informing operators and river users of planned operations in area and highlighting times when project barges are likely to be servicing the site
- b. appoint Berthing Co-ordinator who would liaise with other local operators and co-ordinate safe project vessel operations in line with other local river traffic
- c. identify an alternative turning zone for rowers for turning to Surrey on an ebb tide at high tide
- d. regularly communicate with TRRC and recreational river user community to inform them of project operations and planned work.

7.3 Proximity to Putney Bridge

7.3.1 Putney Bridge has five arches and arches No 2, 3 and 4 are designated as working arches in the PLA's *Mariners Guide to Bridges on the Tidal Thames*. Arch No2 is normally used by vessels heading upstream and arch No4 by vessels that are heading downstream, subject to the height of the tide. Arch No3 is for two-way traffic when the tide does not allow arches No2 and 4 to be used.

Figure 7.6 Putney Bridge

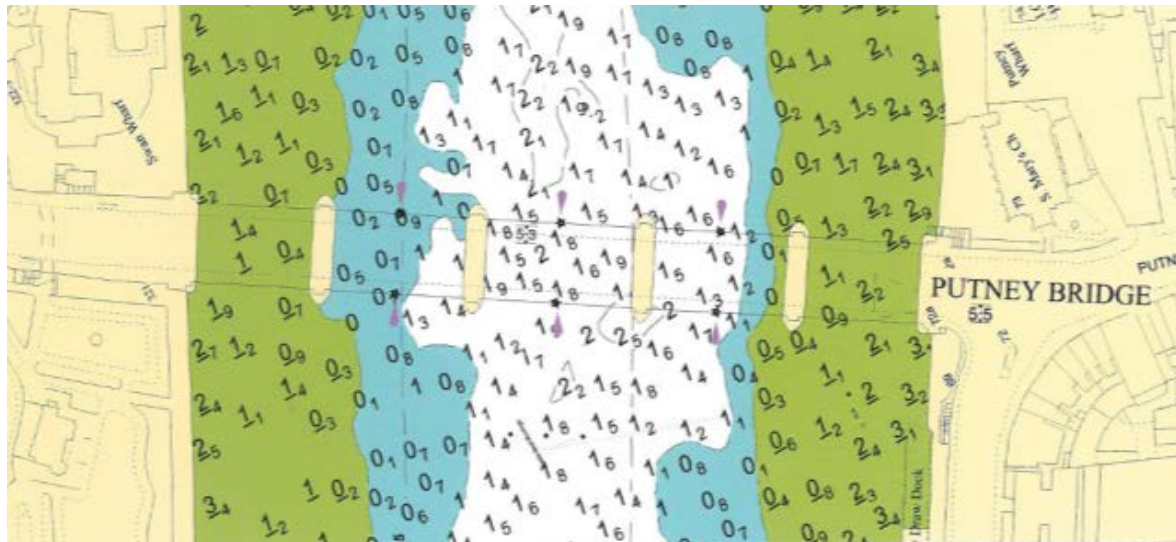

- 7.3.2 While the temporary cofferdam is in place, it is expected that arch No5 would be closed to all vessels because the cofferdam would extend beneath the bridge arch. This is not expected to affect the majority of vessel operations in this area because the arch is not frequently used due to the limited available water and air drafts.
- 7.3.3 During construction recreational river users, including rowing boats, would not be able to use the Putney draw dock to launch and recover vessels. A temporary slipway would be constructed, as part of construction Phase A, prior to work commencing on the cofferdam. The provision of a temporary slipway upstream of the site reduces the likely impact of work activity on recreational users.
- 7.3.4 Vessels transiting through arch No4 would be required to exercise caution during construction Phase Band D of the project when jack-up barges would be supporting construction and removal of the cofferdam.

Actions required

- 7.3.5 A number of actions, specific to the issue, have been commenced or completed in order to assist the project to provide a robust and evidence-based assessment to the PLA. These actions include:
- conduct analysis of freight traffic in transit through this section of the river
 - record / observe leisure/recreational river traffic in area: vessels under 13.7m navigating outside of the authorised channel;
 - observation: record / photograph leisure / recreational traffic
 - review HR Wallingford's fluvial modelling report for this site to determine the effect on river users from any increase in flow.

Mitigation of issues: Design

- 7.3.6 The following measures are embedded in the designs and this assessment therefore only assesses the residual risk assuming the effective implementation of these measures:
- a. The design and in-river footprint of the temporary and permanent works site has been minimised so that intrusion into the river is minimal and set back from the authorised channel, where possible.
 - b. A temporary slipway would be constructed upstream of Putney Pier.
 - c. The design of the permanent works and slipway takes into consideration PLA's concerns regarding potential impact hazards.

Mitigation of issues: Physical

- a. assessment and understanding of operating procedures to ensure minimal disruption/interaction with existing users
- b. timing of barge movements and construction activities (sheet piling of cofferdam) to minimise impact on existing users and to take into consideration one-off river events.

Mitigation of issues: River operations

- a. issue Notice to Mariners informing operators and river users of planned operations within the area and highlighting times when Project vessels are likely to be servicing the site
- b. issue Notice to Mariners informing operators and river users of planned bridge arch closures
- c. appoint Berthing Co-ordinator to liaise and be in communication with all operators in the local area and on hand to deal with potential areas of concern or conflict
- d. regularly communicate with TRRC and recreational river user community to inform them of project operations and planned work.

7.4 Putney Bridge arch closures

- 7.4.1 It is expected that arch No5 would be closed to all vessels during construction and whilst the cofferdam is in place, as the cofferdam would extend beneath the bridge arch with construction plant located inside the river.
- 7.4.2 Closure of arch No4 may be required during some construction activities.

Figure 7.7 Putney Bridge proceeding upstream

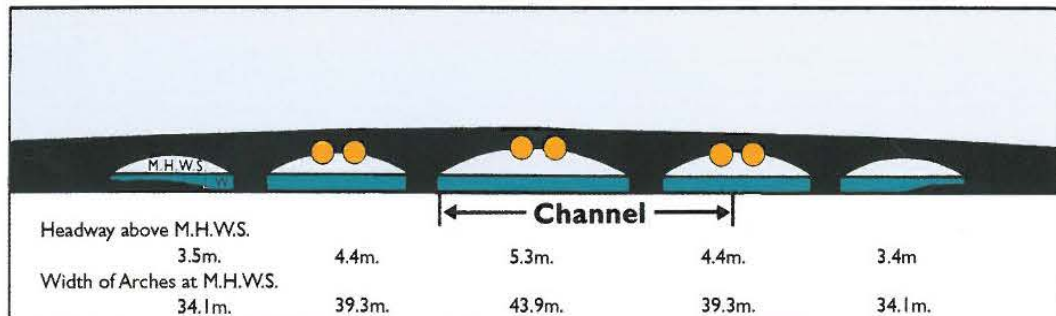
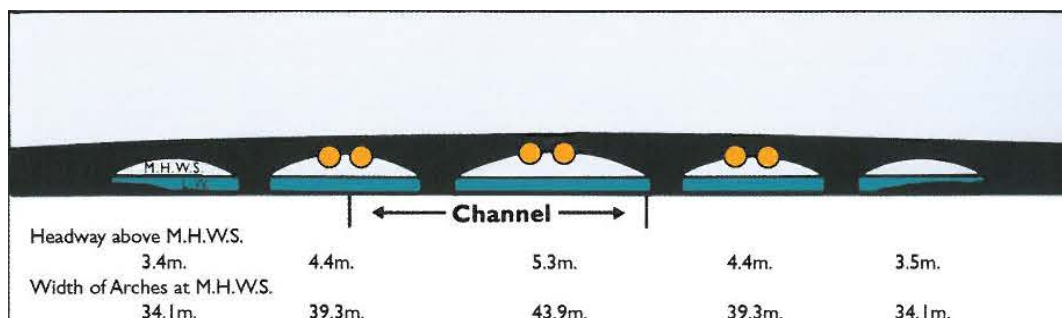

Figure 7.8 Putney Bridge proceeding downstream



- 7.4.3 The requirement to close arch No4 that has been identified as a potential navigational hazard at the Putney Embankment Foreshore site.

Actions required

- 7.4.4 A number of actions, specific to the issue, have been commenced or completed in order to assist the project to provide a robust and evidence-based assessment to the PLA. These actions include:
- review of river vessel survey conducted at Barn Elms (conducted on 2nd Nov 2011)
 - observation - record / photograph leisure / recreational traffic:
 - investigate the use of fendering or a boom style arrangement (Figure 7.9) to direct recreational away from equipment, plant and construction activities when transiting through arch No4.
 - The use of a boom arrangement was discussed with the PLA at a project progress meeting on the 2nd July 2012.
 - The PLA advised that such an arrangement may prove impracticable and introduce navigational hazards greater than those that it was intended to mitigate.
 - It was acknowledged that moving the boom and re-positioning it each time a barge accessed the site could negate the benefits that such a system may provide.

Figure 7.9 Boom arrangement at Putney Embankment Foreshore

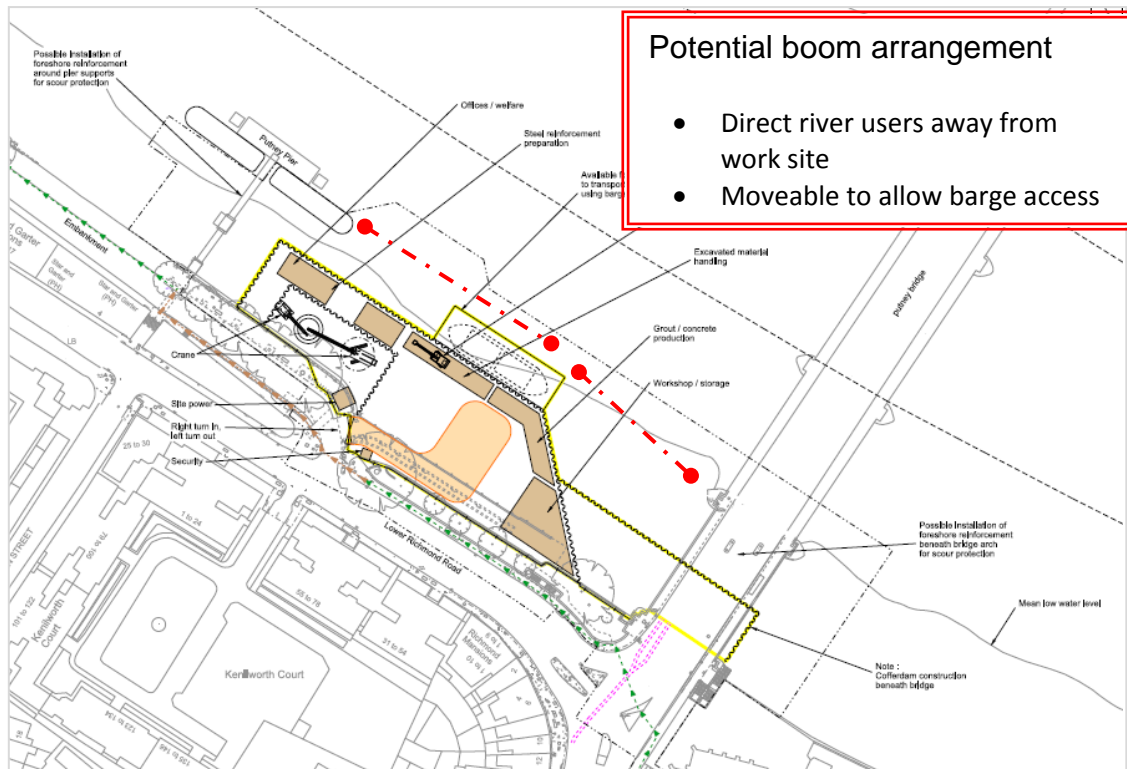

Mitigation of issues: Design

7.4.5 The following measures are embedded in the designs and this assessment therefore only assesses the residual risk assuming the effective implementation of these measures:

- a. Provision of a temporary slipway upriver of Putney Pier reduces the requirement for recreational vessels to transit through arches No5 and No4. There should be no requirement for vessels to use arch No5 throughout the period of the temporary works.

7.4.6 The following sections set out the proposed mitigation measures to address the residual risks.

Mitigation of issues: Physical

- a. Assessment and understanding of operating procedures to ensure minimum disruption/interaction with existing users.

Mitigation of issues: River operations

- b. issue Notice to Mariners informing operators and river users of planned operations in area and highlighting times when project barges are likely to be servicing the site
- c. issue Notice to Mariners informing operators and river users of planned bridge arch closure
- d. appoint Berthing Co-ordinator to liaise and be in communication with all operators in the local area and be on hand to deal with potential areas of concern/conflict.

7.5 Impact on operators using Putney Pier

- 7.5.1 Putney Pier is owned and operated by Livett's Launches. Use of the pier is strictly by request however bookings for private vessels as well as for charter and commercial craft are available.
- 7.5.2 A Monday to Friday service from Putney Pier to Blackfriars Pier is operated by Complete Pleasure Boats (as detailed on TfL website).

Figure 7.10 - Putney Pier²



- 7.5.3 Currently there are two house boats moored on the foreshore side of the jetty, with the downstream vessel identified as being within the LLAU. The downstream vessel may need to be relocated during construction of the cofferdam. It is anticipated that if relocated, the houseboat would be temporarily repositioned on the upstream side of the pier.
- 7.5.4 Impact on Putney Pier operations is most likely to be experienced during construction phases B, C and D with plant movements and construction activities taking place.
- 7.5.5 The location and design of the permanent works structure is not expected to impact on operations at Putney Pier.
- 7.5.6 The impact from construction activities and project associated vessel movements on operators using Putney Pier has been identified as presenting a potential navigational hazard.

Actions required

- 7.5.7 A number of actions, specific to the issue, have been commenced or completed in order to assist the project to provide a robust and evidence-based assessment to the PLA. These actions include:
- consultation with Livett's Launches

²The copyright on this image is owned by **Alexander P Kapp** and is licensed for reuse under the Creative Commons Attribution-ShareAlike 2.0 license

- b. consultation with house boat owners
- c. review of river vessel survey conducted at Barn Elms
- d. observation - record / photograph operations at Putney Pier.

Mitigation of issues: Design

7.5.8 The following measures are embedded in the designs and this assessment therefore only assesses the residual risk assuming the effective implementation of these measures:

- a. The design of the cofferdam minimises its extent to ensure it is located away from Putney Pier and set back from the authorised channel (approximately 50m).

7.5.9 The following sections set out the proposed mitigation measures to address the residual risks.

Mitigation of issues: Physical

- a. consultation with Livett's Launches
- b. barge sizes and barge movements to be optimised in order to reduce impact on existing river users. Construction barge movements to be scheduled to avoid river traffic associated with the pier where practicable.

Mitigation of issues: River operations

- a. regular communication and liaison with Livett's Launches.

7.6 Impact and CSO outfall location

7.6.1 During initial consultation a number of stakeholders expressed a wish to be able to moor alongside the proposed new structure at Putney Embankment Foreshore.

7.6.2 To provide for vessel mooring and footing for vessel operators berthing alongside the permanent structure, the proposed design of the permanent structure has guardrails set back approximately 400mm from the structure's edge, and features fendering equipment.

7.6.3 The PLA expressed concern that the infrequent CSO discharge outfall located at this site of 5m³/s at 2m/s (4knots) could push a vessel from its mooring, stating that this arrangement was unsatisfactory.

7.6.4 In order to reduce the risk of a vessel being taken from its mooring location two mitigation measures were proposed:

- a. consider the location or configuration of the discharge outfall and mitigate its effect where possible.
- b. discourage vessels from mooring in close proximity to the outfall.

7.6.5 Although the probability of such a discharge was would be low (approximately once in a typical year) it was agreed that this did present a navigational hazard and that due consideration should be given to the issue.

Actions required

- 7.6.6 A number of actions, specific to the issue, have been commenced or completed in order to assist the project to provide a robust and evidence-based assessment to the PLA. These actions include:
- a. assess the location of the discharge outfall and consider relocating/changing the current arrangement to minimise the risk of vessels being pushed off their moorings
 - b. assess design of permanent structure and suitability to moor recreational craft against it
 - c. consider the benefits of conducting CSO discharge rate modelling and potential impact on moored vessels.

Mitigation of issues: Design

- 7.6.7 The following measures are embedded in the designs and this assessment therefore only assesses the residual risk assuming the effective implementation of these measures:
- a. The design of the permanent structure and associated infrastructure, including fendering and guardrails, supports mooring requirements.
 - b. The design, location and configuration of CSO outfall discharge minimises impact on moored vessels.
 - c. The design of permanent structure discourages recreational river users from mooring alongside the river wall section located in direct proximity to the outfall.
 - d. The size and configuration of the CSO outlets were modified to minimise the velocity of discharges.

- 7.6.8 The following sections set out the proposed mitigation measures to address the residual risks.

Mitigation of issues: Physical

- a. display warning notices/sign at site informing river user community of the possibility of CSO discharge and that vessel owners mooring against the permitted sections of the permanent structure (away from the CSO outlets) do so at their own risk.

Mitigation of issues: River operations

- a. None identified.

7.7 Impact of permanent structure on leisure and recreational river users

- 7.7.1 The original draw dock would be reinstated in its original location and alignment upon completion of the works. The permanent structure would be perpendicular to the draw dock, presenting a possible impact hazard to those using the facility.

- 7.7.2 The draw dock is used by river users to launch and recover a variety of recreational craft with a wide range of experience and river knowledge.
- 7.7.3 The existing draw dock does not extend to low water. The majority of vessel launches and recoveries are therefore performed between mean water and high tide level, typically on a rising tide. However, during spring tides it becomes a much more difficult procedure around high water, due to the water level reaching the road. As there are no markings to users where the edges are, it is best to carry out launching and recovery at about half tide. Using the draw dock around spring high water can lead to incidents, with owners either damaging their boats or flooding vehicles.
- 7.7.4 During consultation with the PLA and local stakeholders, it was suggested that the project considers widening the draw dock, primarily to improve the overall use of the facility and to lessen the impact that the permanent structure would have on users of the Draw Dock. The design of the permanent foreshore structure has been developed to minimise impact upon the historic slipway, so that it may retain its current location and alignment. The current design would not preclude the future widening of the slipway by others if required, but it is not currently proposed to widen the slipway as part of the project.

Figure 7.11 Location of permanent structure

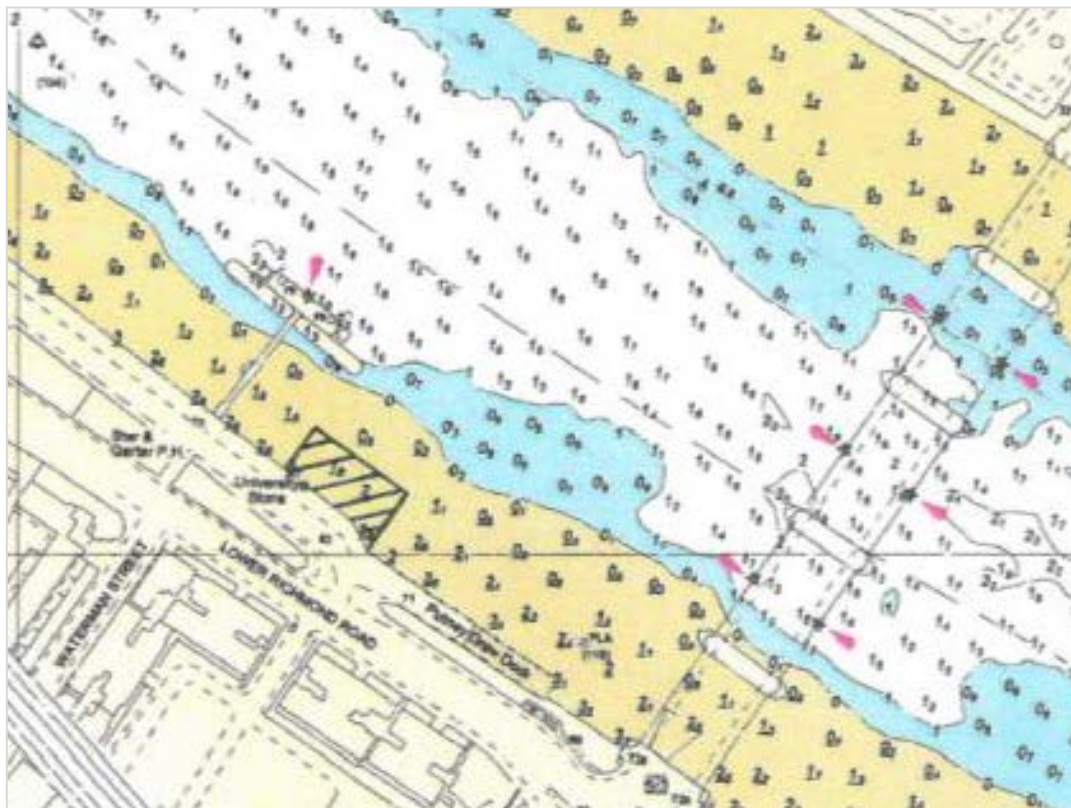

Actions required

- 7.7.5 A number of actions, specific to the issue, have been commenced or completed in order to assist the project to provide a robust and evidence-based assessment to the PLA. These actions include:
- assess risk to structure and vessels in the event of impact;

- b. identify suitable timber fendering arrangement and incorporate into design of permanent structure;
- c. consult with Livett's Launches (the owner of Putney Pier) and draw dock users;

Mitigation of issues: Design

7.7.6 The following measures are embedded in the designs and this assessment therefore only assesses the residual risk assuming the effective implementation of these measures:

- a. The design and in-river footprint of the permanent works site has been minimised so that intrusion into the river is kept as small as possible while incorporating the necessary works and is set back from the authorised channel. This reduces the extent that work sites extend into the river and therefore reduces the likely impact on existing river users.
- b. The design of permanent structure includes continuous timber fendering along the downstream face to provide impact protection to the structure and reduce damage to vessels in the event of contact.

7.7.7 The following sections set out the proposed mitigation measures to address the residual risks.

Mitigation of issues: Physical

- a. assessment and understanding of operating procedures to ensure minimum disruption/interaction with existing users
- b. consultation with Chas Newens Marine and Hurlingham Yacht Club
- c. consultation with Thames Executive Charters, who currently use the draw dock on a weekly basis, to understand their requirements and operating procedures.

Mitigation of issues: River operations

- a. Issue Notice to Mariners informing operators and river users of planned operations in area, highlighting times when project barges are likely to be servicing the site.

7.8 Impact of project works on special river events

7.8.1 A number of high profile river events take place on the River Thames each year. These include, but are not limited to, the following which take place in the study area:

- a. The University Boat Race (Putney - Mortlake)
- b. The Great River Race (Millwall - Richmond)
- c. Head of the River Fours (Mortlake - Putney)
- d. Eights Head of the River Race (Mortlake - Putney)

7.8.2 In March 2012 the PLA published Notice to Mariners No. U7 of 2012 titled 'Annual Event Calendar Rowing/Paddling Spring/Summer 2012' that listed

all major events likely to have an effect on navigation between Teddington and Putney. The list is not an exhaustive list of events in the upper reaches of the tidal Thames however, it does include all major events scheduled throughout the year.

- 7.8.3 The project recognises that conducting barge operations during these events introduces navigational hazards, both to general river traffic, competitors, race organisers/officials and to project operations.
- 7.8.4 Construction activities would be temporarily suspended during the University Boat Race and other special river events that start or finish at the site to avoid navigational hazards.

7.9 Relocation of moorings: Temporary slipway

- 7.9.1 In order to minimise the impact on, and disruption to, existing river users at Putney during the construction of the temporary and permanent works site, it is proposed that a temporary slipway is constructed.
- 7.9.2 The temporary slipway would be built approximately 300m to the west of Putney Bridge, at a site adjacent to the Chas Newens Marine office. The site for the temporary slipway is adjacent to an existing slipway that configured perpendicular to river and which is currently used to launch and recover craft.
- 7.9.3 Construction of the temporary slipway would involve working from jack-up or spud leg barges or inter-tidal working. Initially, steel tubular piles for the slipway structure support and mooring points would be installed, and then the deck (formed from prefabricated steel) would be assembled on site.
- 7.9.4 Figure 7.12 shows the proposed location of the temporary slipway in relation to the eight moorings currently used by Chas Newens Marine. The largest moored vessel measures 22.5 meters in length and when the tide turns the vessel could swing into the area designated as the working area. It is therefore likely that some or all of the moorings would need to be suspended during the initial construction and ultimate removal stages of the slipway (phase A and F). The turning circle of each moored vessel is identified by a white circle and the maximum extent of the working area during construction is highlighted in green.
- 7.9.5 The existing moorings would be available for use once the temporary slipway has been constructed.
- 7.9.6 The project has been in consultation with the PLA and Chas Newens Marine in order to identify an alternative location for the moorings.
- 7.9.7 At a meeting on the 18th April 2012, three possible locations were proposed and discussed, with a number of advantages and disadvantages identified for each site. Providing an alternative location that meets the requirements of the current users and does not negatively impact on navigational safety is considered within this section.

Figure 7.12 Relocation of existing mooring: Temporary slipway

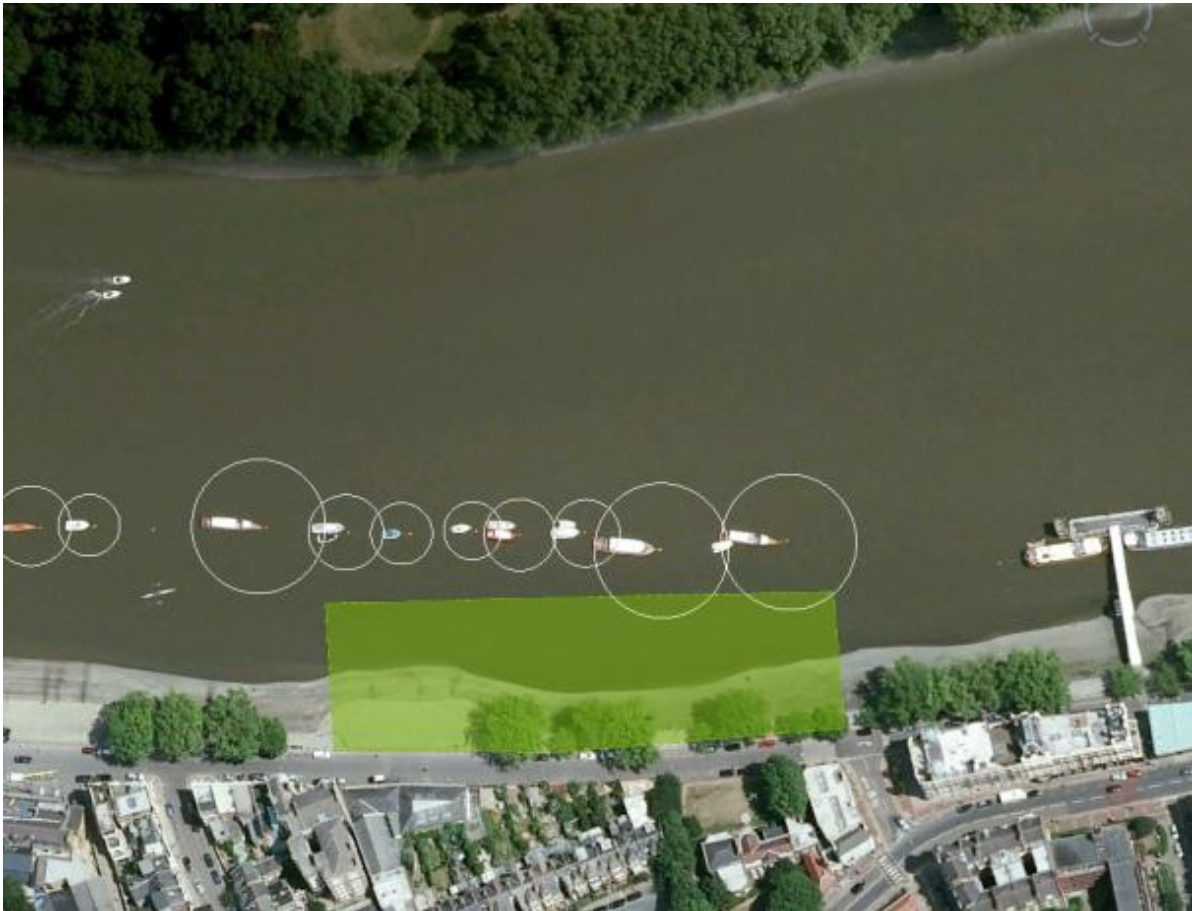

7.9.8 Figure 7.13 provides a representation of the three sites identified as possible alternative locations:

- a. Option A:
 - i less water depth than current location
 - ii moorings may get pushed out into the authorised channel
 - iii vessels moored may be affected by proximity to Beverley Brook
 - iv close to Barn Elms Rowing Club and associated activities in nearby area
 - v moored vessels would not be visible to the their owner, Chas Newens Marine.
- b. Option B:
 - i comparable water depth with current location
 - ii could be set back from the authorised channel
 - iii moored vessels would not be visible to their owner, Chas Newens Marine.
- c. Option C:
 - i comparable water depth with current location
 - ii nearest to Chas Newens Marine facilities

- iii clear line of sight to mooring occupier, Chas Newens Marine
- iv may impact on rowers crossing from Surrey side.

7.9.9 A decision as to which option would be adopted has not been reached. Consultation with stakeholders continues.

Figure 7.13 Alternative mooring locations

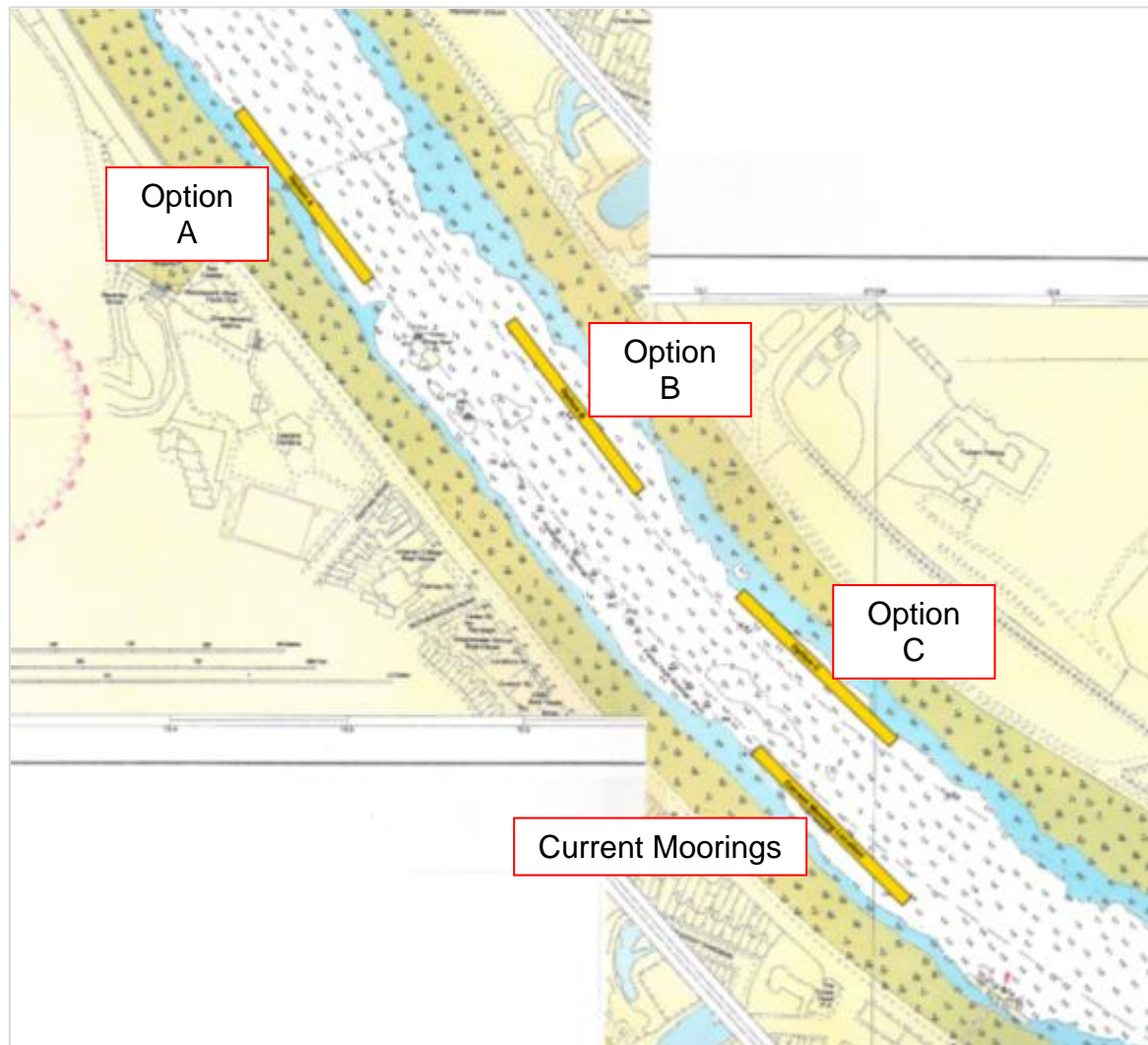

8 General navigational hazards

- 8.1.1 In addition to the 'navigation issues' considered within this report, navigational hazards associated with day-to-day river operations were also identified. These hazards relate to the interaction of the project-related marine traffic with existing river users.
- 8.1.2 'Worst Credible' consequences and the probability of the consequences were considered in the assessment. As a result, in some cases the Worst Credible score was lower than the 'Most Likely' score. This is explained by the probability that a 'moderate injury', for example, is higher than the probability of a 'single fatality'.
- 8.1.3 Full hazard details are contained in Annex A through to Annex I.

8.2 Project phases A to D: Most likely

Hazard Id	Hazard title	Hazard description	Phase	Score			
				People	Environment	Operational	Media
1	Emergency arch closure - arch No2, 3 or 4	There may be an emergency requirement to close arch No2, 3 or 4.	A	4	2	3	3
			B	4	2	3	3
			C	4	2	3	3
			D	4	2	3	3
2	Planned arch closure - arch No2, 3 or 4	There may be a requirement to close arch No2, 3 or 4 for maintenance.	A	4	2	3	3
			B	4	2	3	3
			C	4	2	3	3
			D	N/A	N/A	N/A	N/A
3	Planned arch closure - arch No5	During construction/use/deconstruction of the cofferdam, the project proposes to close arch No 5 to all navigation.	A	8	4	8	4
			B	8	4	8	4
			C	8	4	8	4
			D	N/A	N/A	N/A	N/A
4	Increase in flow	Changes to the hydrodynamics of the river may affect passing vessels, particularly through the arches of Putney Bridge.	A	9	6	6	9
			B	9	6	6	9
			C	9	6	6	9
			D	9	6	6	9
5	Contact - High Speed Passenger Vessel with	A High Speed Passenger Vessel comes into contact	A	8	4	6	8
			B	8	4	6	8

8 General navigational hazards

	worksite	with project's temporary or permanent worksite at Putney Embankment Foreshore.	C	8	4	6	8
			D	9	6	9	12
6	Contact - Class V passenger vessel with worksite	A Class V passenger vessel comes into contact with project's temporary or permanent worksite at Putney Embankment Foreshore.	A	8	4	6	8
			B	8	4	6	8
			C	8	4	6	8
			D	9	6	9	12
7	Contact - private leisure vessel with worksite	A private leisure vessel comes into contact with project's temporary or permanent worksite at Putney Embankment Foreshore.	A	8	4	6	8
			B	8	4	6	8
			C	8	4	6	8
			D	9	6	9	12
8	Contact - commercial freight operator with worksite	A commercial freight operator comes into contact with project's temporary or permanent worksite at Putney Embankment Foreshore.	A	6	4	6	6
			B	6	4	6	6
			C	6	4	6	6
			D	6	4	6	6
9	Contact - tug and tow with worksite	A tug and tow comes into contact with project's temporary or permanent work site at Putney Embankment Foreshore.	A	6	4	6	6
			B	6	4	6	6
			C	6	4	6	6
			D	6	4	6	6
10	Grounding - all vessels due to 'Squat Effect'	At periods of low water, vessels may be affected by the 'Squat Effect', causing them to be closer to the river bed than expected.	A	6	2	6	6
			B	6	2	6	6
			C	6	2	6	6
			D	6	2	6	6
11	Mooring breakout	A vessel involved in project activities breaks free from moorings.	A	6	4	6	4
			B	6	4	6	4
			C	6	4	6	4
			D	N/A	N/A	N/A	N/A
12	Collision - High Speed Passenger Vessel (construction/deconstruction)	A vessel conducting project construction/deconstruction activities collides with a High Speed Passenger Vessel (eg, Thames Clipper) in the vicinity of Putney Embankment Foreshore.	A	6	4	6	8
			B	N/A	N/A	N/A	N/A
			C	6	4	6	8
			D	N/A	N/A	N/A	N/A
13	Collision - Class V passenger vessel (construction/deconstru	A vessel conducting project construction/deconstruction activities collides with a Class V passenger vessel	A	6	4	6	8
			B	N/A	N/A	N/A	N/A
			C	6	4	6	8

8 General navigational hazards

	ction)	in the vicinity of Putney Embankment Foreshore.	D	N/A	N/A	N/A	N/A
14	Collision - private leisure vessel (construction/deconstruction)	A vessel conducting project construction/deconstruction activities collides with a private leisure vessel in the vicinity of Putney Embankment Foreshore.	A	9	6	9	9
			B	N/A	N/A	N/A	N/A
			C	9	6	9	9
			D	N/A	N/A	N/A	N/A
15	Collision - commercial freight operator (construction/deconstruction)	A vessel conducting project construction/deconstruction activities collides with a commercial freight operator in the vicinity of Putney Embankment Foreshore.	A	6	9	6	9
			B	N/A	N/A	N/A	N/A
			C	6	9	6	9
			D	N/A	N/A	N/A	N/A
16	Collision - tug and tow (construction/deconstruction)	A vessel conducting project construction/deconstruction activities collides with a tug and tow in the vicinity of Putney Embankment Foreshore.	A	6	9	6	9
			B	N/A	N/A	N/A	N/A
			C	6	9	6	9
			D	N/A	N/A	N/A	N/A
17	Contact with Putney Bridge (construction/deconstruction)	A vessel conducting project construction/deconstruction activities makes contact with Putney Bridge, including arches, abutments and any associated bridge superstructure.	A	6	9	6	9
			B	N/A	N/A	N/A	N/A
			C	6	3	6	6
			D	N/A	N/A	N/A	N/A
18	Collision - High Speed Passenger Vessel (delivery/material removal)	A vessel conducting project delivery/material removal activities collides with a High Speed Passenger Vessel (eg, Thames Clipper) in the vicinity of Putney	A	N/A	N/A	N/A	N/A
			B	6	4	6	8
			C	N/A	N/A	N/A	N/A
			D	N/A	N/A	N/A	N/A
19	Collision - Class V passenger vessel (delivery/material removal)	A vessel conducting project delivery/material removal activities collides with a Class V passenger vessel in the vicinity of Putney Embankment Foreshore.	A	N/A	N/A	N/A	N/A
			B	6	4	6	8
			C	N/A	N/A	N/A	N/A
			D	N/A	N/A	N/A	N/A
20	Collision - private leisure vessel (delivery/material removal)	A vessel conducting project delivery/material removal activities collides with a private leisure vessel in the vicinity of Putney Embankment Foreshore.	A	N/A	N/A	N/A	N/A
			B	9	6	9	9
			C	N/A	N/A	N/A	N/A
			D	N/A	N/A	N/A	N/A
21	Collision - commercial freight operator (delivery/material	A vessel conducting project delivery/material removal activities collides with a commercial freight operator	A	N/A	N/A	N/A	N/A
			B	6	9	6	9
			C	N/A	N/A	N/A	N/A

8 General navigational hazards

	removal)	in the vicinity of Putney Embankment Foreshore.	D	N/A	N/A	N/A	N/A
22	Collision - tug and tow (delivery/material removal)	A vessel conducting project delivery/material removal activities collides with a tug and tow in the vicinity of Putney Embankment Foreshore.	A	N/A	N/A	N/A	N/A
			B	6	9	6	9
			C	N/A	N/A	N/A	N/A
			D	N/A	N/A	N/A	N/A
23	Contact - Putney Bridge (delivery/material removal)	A vessel conducting project delivery/material removal activities makes contact with Putney Bridge, including arches, abutments and any associated bridge superstructure.	A	N/A	N/A	N/A	N/A
			B	6	3	6	6
			C	N/A	N/A	N/A	N/A
			D	N/A	N/A	N/A	N/A

8.3 Project phases A to D: Worst case

Table 8.2 Worst credible risk scores

Hazard Id	Hazard title	Hazard description	Phase	Score			
				People	Environment	Operational	Media
1	Emergency arch closure - arch No2, 3 or 4	There may be an emergency requirement to close arch No2, 3 or 4.	A	5	3	4	4
			B	5	3	4	4
			C	5	3	4	4
			D	5	3	4	4
2	Planned arch closure - arch No2, 3 or 4	There may be a requirement to close arch No2, 3 or 4 for maintenance.	A	5	3	4	4
			B	5	3	4	4
			C	5	3	4	4
			D	N/A	N/A	N/A	N/A
3	Planned arch closure - arch No5	During construction/use/deconstruction of the cofferdam, the project proposes to close arch No5 to all navigation.	A	10	6	10	6
			B	10	6	10	6
			C	10	6	10	6
			D	N/A	N/A	N/A	N/A
4	Increase in flow	Changes to the hydrodynamics of the river may affect passing vessels, particularly through the arches of Putney Bridge.	A	12	9	9	12
			B	12	9	9	12
			C	12	9	9	12
			D	12	9	9	12

8 General navigational hazards

5	Contact - High Speed Passenger Vessel with worksite	A High Speed Passenger Vessel comes into contact with project's temporary or permanent worksite at Putney Embankment Foreshore.	A	10	6	8	10
			B	10	6	8	10
			C	10	6	8	10
			D	10	6	8	10
6	Contact - Class V passenger vessel with worksite	A Class V passenger vessel comes into contact with the project's temporary or permanent worksite at Putney Embankment Foreshore.	A	10	6	8	10
			B	10	6	8	10
			C	10	6	8	10
			D	10	6	8	10
7	Contact - private leisure vessel with worksite	A private leisure vessel comes into contact with project's temporary or permanent worksite at Putney Embankment Foreshore.	A	10	6	8	8
			B	10	6	8	8
			C	10	6	8	8
			D	10	6	8	8
8	Contact - commercial freight operator with worksite	A commercial freight operator comes into contact with project's temporary or permanent worksite at Putney Embankment Foreshore.	A	8	6	8	6
			B	8	6	8	6
			C	8	6	8	6
			D	8	6	8	6
9	Contact - tug and tow with worksite	A tug and tow comes into contact with project's temporary or permanent worksite at Putney Embankment Foreshore.	A	8	6	8	6
			B	8	6	8	6
			C	8	6	8	6
			D	8	6	8	6
10	Grounding - all vessels due to 'Squat Effect'	At periods of low water, vessels may be affected by the 'Squat Effect', causing them to be closer to the river bed than expected.	A	8	4	8	8
			B	8	4	8	8
			C	8	4	8	8
			D	8	4	8	8
11	Mooring breakout	A vessel involved in project activities breaks free from moorings.	A	8	6	8	6
			B	8	6	8	6
			C	8	6	8	6
			D	N/A	N/A	N/A	N/A
12	Collision - High Speed Passenger Vessel (construction/deconstruction)	A vessel conducting project construction/deconstruction activities collides with a High Speed Passenger Vessel (eg, Thames Clipper) in the vicinity of Putney Embankment Foreshore.	A	6	4	6	8
			B	N/A	N/A	N/A	N/A
			C	6	4	6	8
			D	N/A	N/A	N/A	N/A
13	Collision - Class V	A vessel conducting	A	6	4	6	8

8 General navigational hazards

	passenger vessel (construction/deconstruction)	project construction/deconstruction activities collides with a Class V passenger vessel in the vicinity of Putney Embankment Foreshore.	B	N/A	N/A	N/A	N/A
			C	8	4	6	8
			D	N/A	N/A	N/A	N/A
14	Collision - private leisure vessel (construction/deconstruction)	A vessel conducting project construction/deconstruction activities collides with a private leisure vessel in the vicinity of Putney Embankment Foreshore.	A	8	6	8	8
			B	N/A	N/A	N/A	N/A
			C	8	6	8	8
			D	N/A	N/A	N/A	N/A
15	Collision - commercial freight operator (construction/deconstruction)	A vessel conducting project construction/deconstruction activities collides with a commercial freight operator in the vicinity of Putney Embankment Foreshore.	A	9	12	9	9
			B	N/A	N/A	N/A	N/A
			C	9	12	6	6
			D	N/A	N/A	N/A	N/A
16	Collision - tug and tow (construction/deconstruction)	A vessel conducting project construction/deconstruction activities collides with a tug and tow in the vicinity of Putney Embankment Foreshore.		9	12	9	9
			B	N/A	N/A	N/A	N/A
			C	9	12	9	9
			D	N/A	N/A	N/A	N/A
17	Contact - Putney Bridge (construction/deconstruction)	A vessel conducting project construction/deconstruction activities makes contact with Putney Bridge, including arches, abutments and any associated bridge superstructure.	A	9	6	9	9
			B	N/A	N/A	N/A	N/A
			C	9	6	9	9
			D	N/A	N/A	N/A	N/A
18	Collision - High Speed Passenger Vessel (delivery/material removal)	A vessel conducting project delivery/material removal activities collides with a High Speed Passenger Vessel (eg, Thames Clipper) in the vicinity of Putney Embankment Foreshore.	A	N/A	N/A	N/A	N/A
			B	6	4	6	8
			C	N/A	N/A	N/A	N/A
			D	N/A	N/A	N/A	N/A
19	Collision - Class V passenger vessel (delivery/material	A vessel conducting project delivery/material removal activities collides with a Class V	A	N/A	N/A	N/A	N/A
			B	6	4	6	8
			C	N/A	N/A	N/A	N/A

8 General navigational hazards

	removal)	passenger vessel in the vicinity of Putney.	D	N/A	N/A	N/A	N/A
20	Collision - private leisure vessel (delivery/material removal)	A vessel conducting project delivery/material removal activities collides with a private leisure vessel in the vicinity of Putney Embankment Foreshore.	A	N/A	N/A	N/A	N/A
			B	8	6	8	8
			C	N/A	N/A	N/A	N/A
			D	N/A	N/A	N/A	N/A
21	Collision - commercial freight operator (delivery/material removal)	A vessel conducting project delivery/material removal activities collides with a commercial freight operator in the vicinity of Putney Embankment Foreshore.	A	N/A	N/A	N/A	N/A
			B	9	12	9	9
			C	N/A	N/A	N/A	N/A
			D	N/A	N/A	N/A	N/A
22	Collision - tug and tow (delivery/material removal)	A vessel conducting project delivery/material removal activities collides with a tug and tow in the vicinity of Putney Embankment Foreshore.	A	N/A	N/A	N/A	N/A
			B	9	12	9	9
			C	N/A	N/A	N/A	N/A
			D	N/A	N/A	N/A	N/A
23	Contact - Putney Bridge (delivery/material removal)	A vessel conducting project delivery/material removal activities makes contact with Putney Bridge, including arches, abutments and any associated bridge superstructure.	A	N/A	N/A	N/A	N/A
			B	9	6	9	9
			C	N/A	N/A	N/A	N/A
			D	N/A	N/A	N/A	N/A

This page is intentionally left blank

9 Mitigation measures

9.1 Existing mitigation

9.1.1 Existing safeguards (measures that manage the risk) in the form of control measures and relevant PLA guidance, are set out in Table 9.1 together with any additional controls deemed desirable or necessary to reduce risk to a level that is ALARP. The risk is assessed taking account of the impact of these various safeguards and controls.

Table 9.1 Existing safeguards

• Boat Masters License	• Vessel Master Experience
• MCA - MGN 199 (M) Dangers of Interaction	• Permanent/Temporary Notice to Mariners
• Aids to Navigation	• Passage Planning
• Safe Systems of Work	• Tug Operator Procedures
• Contractors Risk Assessment	• BML Local Knowledge Endorsement
• River Bylaws	• General Directions
• VTS Qualification	• VHF Communications
• Bridge Special Signal Lights	• Ship Towage Code of Practice
• VTS Navigational Broadcast	• Emergency Plans and Procedures
• Thames AIS	• Oil Spill Contingency Plan
• PLA Bridge Guide	• Maintenance / Inspection Routines
• Admiralty Charts	• COLREGs
• Tide Gauges	• Qualified Crew
• Tide Tables	• Barge Operators daily check lists
• Accurate Tidal Information	• High Speed Craft Code

9.1.2 The above list is not exhaustive but was used to highlight the measures that are most relevant to project operations.

9.2 Proposed mitigation

9.2.1 The proposed risk reduction/mitigation measures were divided into three categories: design, physical and river operations. This is to provide the PLA with assurance that the measures proposed throughout this assessment have regard to the project's responsibility to reduce risk rather than focussing on local authorities' and existing river users' responsibilities.

9.3 Design

- 9.3.1 The following measures are embedded in the designs and this assessment therefore only assesses the residual risk assuming the effective implementation of these measures:
- a. The design and in-river footprint of the temporary and permanent works site was minimised so that intrusion into the river is minimal and set back from the authorised channel.
 - b. A temporary slipway would be constructed upstream of Putney Pier and would remain in place for the duration of the construction period (i.e. while Putney draw dock is unavailable).
 - c. The permanent works design includes fendering and takes into consideration PLA's concerns regarding potential impact hazards including striking the downstream face. The design incorporates continuous timber fendering and a radius to the 'outside corners' of the structure to minimise any impacts to both structure and vessel, should a collision occur.
 - d. The structure was designed so as to discourage vessels from mooring against it permanently or on a long-term basis. The design of the structure discourages vessels from mooring adjacent to the CSO outfall.
 - e. A lay-by mooring facility would be provided on the upstream end of the permanent structure, away from the CSO outfall. This means that the hand railings would be set back from the edge of the structure to enable users to temporarily step off vessels. Access gates within the handrail would not be provided to discourage long-term mooring. Two mooring bollards would be provided adjacent to the lay-by mooring area. Timber piled fenders would be provided at the lay-by mooring location.
 - f. Timber piled fenders are required along the river face adjacent to the CSO outlets to ensure that the flap valves are not prevented from opening as a result of a moored vessel.
 - g. A temporary slipway would be constructed upstream of Putney Pier, which reduces the requirement for recreational vessels to transit through arches No. 5 and No. 4. There should be no requirement for vessels to use arch No. 5 throughout the period of the temporary works.
 - h. The design of the cofferdam minimises its extent to ensure it is located away from Putney Pier and set back from the authorised channel (approximately 50m).
 - i. The design, location and configuration of CSO outfall discharge minimises impact on moored vessels.
 - j. Construction activities would be temporarily suspended during the University Boat Race and other special river events that start or finish at the site to avoid navigational hazards

- 9.3.2 The following sections set out the proposed mitigation measures to address the residual risks.

9.4 Physical

- a. consultation with the following stakeholders in order to provide a comprehensive understanding of current operating requirements and procedures:
 - i TRRC
 - ii Putney Pier owner (Livett's Launches)
 - iii Thames Executive Charters
 - iv Chas Newens Marine
 - v Hurlingham Yacht Club.
- b. assessment and understanding of operating procedures to ensure minimum disruption/interaction with existing users
- c. restrict project river operations at this site to Monday to Friday only. River operations should not take place on Saturdays when river use is traditionally higher
- d. timing of barge movements and construction activities (sheet piling of cofferdam) to minimise impact on existing users and to take into consideration one-off river events.
- e. barge sizes and barge movements to be optimised in order to reduce impact on existing river users. Construction barge movements to be scheduled to avoid river traffic associated with the pier where practicable.
- f. display warning notices at site informing river user community of the possibility of CSO discharge and that vessel owners mooring against the permanent structure adjacent to the CSO outlets do so at their own risk.

9.5 River operations

- a. planning of operations to take into consideration scheduled river events.
- b. restrict project river operations at this site to Monday - Friday only. River operations not to take place on Saturdays when river use is traditionally greater.
- c. issue Notice to Mariners - informing operators and river users of planned operations in area, highlighting times when project barges are likely to be servicing the site.
- d. issue Notice to Mariners - informing operators and river users of planned bridge arch closures.

- e. Investigate the use of fendering or a boom style arrangement to direct recreational users away from equipment, plant and construction activities when transiting through arch No4.
- f. appoint Berthing Co-ordination Manager to liaise and be in communication with all operators in the local area and to be on hand to deal with potential areas of concern / conflict .
- g. regular communication with TRRC and recreational river user community to inform of Project operations and planned work.
- h. identify an alternative turning zone for rowers for turning to Surrey on an ebb tide at high tide
- i. Warning notices displayed at the site - informing the river user community of the possibility of CSO discharge and that vessel owners moor against the permanent structure at their own risk.
- j. regular communication and liaison with Livett's Launches

Table 9.2 Mitigation measures within the project's control

Procedural	Informational	Qualifications / Personnel	Guidance / Publications	Site Specific
Safe Systems of Work	Sound Warnings	Berth Master (term to be defined)	Temporary Notice to Mariners	Grab Chains
Contractors Risk Assessment	Light Warnings	Qualifications / Competence of on site personnel	Permanent Notice to Mariners	Fendering
Site Working Practises	Anemometer at site			Impact Protection - Temporary Works
Scheduling of barge movements to assist with existing river events				Impact Protection - Permanent Works
				New Tide Gauges / Markers

10 Conclusion

10.1 Assessment

- 10.1.1 This *Navigation Issues and Risk Assessment* assessed the potential impact of the proposed works at Putney Embankment Foreshore on existing users.
- 10.1.2 The project's approach to this assessment comprised stakeholder engagement, analysis of Automatic Identification System (AIS) data, observation of current river operations including a desktop review of hazards, and development of potential mitigation measures.
- 10.1.3 The risk assessment criteria, assessment matrix, terminology and risk classification were provided by the PLA. The assessment also follows the Formal Safety Assessment (FSA) methodology:
- a. stakeholder consultation
 - b. identification of hazards
 - c. hazard analysis.

10.2 Stakeholder engagement

- 10.2.1 A number of issues were identified throughout the risk assessment process, including:
- a. interaction with existing river users
 - b. impact of permanent structure on leisure users utilising Putney Slipway
 - c. impact on vessels moored in vicinity of discharge outfall
 - d. relocation of mooring facilities.
- 10.2.2 During public consultation and throughout the design phases of the project, the project team has engaged with local stakeholders.
- 10.2.3 For the site at Putney Bridge consultation has been undertaken with a number of organisations including:
- a. Adrian Allworth, Thames Executive Charters
 - b. Chris Livett, Livett's Launches
 - c. Chas and Julie Newens, Chas Newens Marine
 - d. Alex Brown, Port of London Authority
 - e. Terry Lawrence, Port of London Authority.

10.3 Risk analysis

- 10.3.1 Hazards at various stages of the project were assessed and scored using the risk matrix and scorecard provided by the PLA and in terms of 'Most Likely' and 'Worst Credible' scenarios.

10.3.2 Annexes A to H provide full details of the hazards identified and the overall scores. The analysis is summarised below in Table 10.1. and Table 10.2.

Table 10.1 Hazard overview: Most likely

Most Likely	Phase A	Phase B	Phase C	Phase D
Extreme: Intolerable risk. Job is not authorised.	0	0	0	0
High: Efforts should be made to reduce risk to ALARP level. Job can only be performed after authorisation from Harbour Master and after further additional controls required under the circumstances.	0	0	0	3
Moderate: Efforts should be made to reduce risk to ALARP level. Job can be performed under direct supervision of Senior Officer.	48	47	47	22
Minor: No additional controls are required, monitoring is required to ensure no changes in circumstances.	17	18	18	5
Slight: No action is required.	3	3	3	2

Table 10.2 Hazard overview: Worst credible

Worst Credible	Phase A	Phase B	Phase C	Phase D
Extreme: Intolerable risk. Job is not authorised.	0	0	0	0
High: Efforts should be made to reduce risk to ALARP level. Job can only be performed after authorisation from Harbour Master and after further additional controls required under the circumstances.	11	11	11	7
Moderate: Efforts should be made to reduce risk to ALARP. Job can be performed under direct supervision of Senior Officer.	48	48	48	21
Minor: No additional controls are required, monitoring is required to ensure no changes in circumstances.	9	9	9	4
Slight: No action is required.	0	0	0	0

10.3.3 Most of the hazards (within the Most Likely assessment) fell within the 'moderate risk' category, requiring effort to be made to reduce the risk to ALARP level.

- 10.3.4 For 'Worst Credible' scenarios, many of the hazards fell within the 'high risk' category, indicating that the work can only be performed after authorisation from the Harbour Master.

10.4 Overall

- 10.4.1 The project site would have an impact on a different user group than the majority of other sites considered for this project. The site is currently heavily used by a variety of users, ranging from small motor launches, sailing boats, rowers and commercial operators.
- 10.4.2 The interaction and impact on existing river users, including rowers and smaller recreational craft, has been highlighted as the major navigational hazard associated with this site.
- 10.4.3 The navigational issues were summarised as follows:
- a. interaction with existing river users - including freight, passenger and recreational vessels
 - b. proximity to Putney Bridge and bridge arch closures: During construction and whilst the cofferdam is in place it is expected that arch No5 would be closed to all vessels as the cofferdam would extend beneath the bridge arch. The proximity of the works to the bridge and any requirement to close arch No3 or 4 (emergency or planned) has been assessed as a navigational hazard
 - c. impact on operations at Putney Pier: It is during construction phases 2, 3 and 4 that the impact on Putney Pier operations is most likely to be experienced, with construction activities and the movement of materials taking place in and around the study area
 - d. impact on vessels moored in vicinity of discharge outfall: A CSO discharge at this site could be in the region of $5\text{m}^3/\text{s}$ at 2m/s (4knots) and could push a vessel from its mooring, if moored against the permanent structure
 - e. impact of permanent structure on leisure users utilising Putney Slipway: On completion of the works at Putney Embankment Foreshore, the original draw dock would be reinstated in its original location, alignment and condition. The permanent structure would be at right angles to the draw dock, presenting a possible impact hazard to those using the slipway
 - f. impact of project activities on special river events: This section of the Thames sees a number of high profile river events, most notably the Oxford - Cambridge Boat Race and the Head of the River Races. Project activities at this site are likely to impact on these types of events, with the movement of materials, construction activities and barge operations likely to present a navigational hazard to river users
 - g. changes in flow resulting from the temporary and permanent in-river structures.
- 10.4.4 This report sought to provide an independent, evidence-based assessment of current river operations and the likely impact that project

operations would have on existing river users in the vicinity of Putney Embankment Foreshore.

The overall responsibility for safety on the River Thames lies with the Port of London Authority, which needs to determine whether the issues and hazards set out in this report present a 'tolerable' navigational risk.

11 Recommendations

11.1 General

- 11.1.1 The project recommends implementing the mitigations set out in Section 6. Additionally, the below should be given consideration:
- 11.1.2 **Relocation of moorings:** Section 6 details the possible requirement to relocate a number of Chas Newens Marine moorings that are located in close proximity to the proposed temporary slipway. The project recommends the affected moorings are relocated whilst the temporary slipway is constructed, and dependant on the method used for removal, during the removal of the temporary slipway.
- 11.1.3 Of the three options proposed as a relocation site, the project recommends that Option C provides the most practical location and minimal impact on existing river users. Agreement from the PLA for the this location would be required.
- 11.1.4 Investigate the use of fendering or a boom style arrangement to direct recreational users away from equipment, plant and construction activities when transiting through arch No4.
- 11.1.5 **Marine Logistics Manager:** Network Rail's major works at Blackfriars Bridge were highlighted as an example of how the river can be used for large-scale civil engineering project's over an extended time period. Dedicated marine logistic managers and experienced marine staff are employed on this project to ensure that project and navigational safety requirements are met. The project recommends taking lessons learnt and best working practices from similar project and implementing them for this project.
- 11.1.6 **Continued communication:** It is recommended that the project continues to maintain communication and liaison with the following:
- a. Thames Regional Rowing Council
 - b. Local stakeholders, including Livetts Launches, Chas Newens Marine, Thames Executive Charters and Hurlingham Yacht Club
 - c. Port of London Authority.
- 11.1.7 **Berthing Co-ordinator:** The project recommends appointing a Berthing Co-ordinator to communicate with all commercial operators in order to facilitate safe berthing and departures from berths in close proximity to project operations. The co-ordinator would co-ordinate departures so that all freight operators, including project barges, could depart on time without adversely impacting on navigation on the tidal Thames.
- 11.1.8 The project recommends considering the designated Berthing Co-ordinator's authority and responsibilities. One responsibility of the Berth Co-ordinator would be to liaise regularly with the PLA and local stakeholders. Clear lines of delegation and responsibilities would need to be established prior to commencing project works to ensure that potential

conflict of interest issues would be managed and to prevent confusion to mariners and authorities regarding various traffic control systems.

Figure 11.1 Potential marine logistics hierarchy

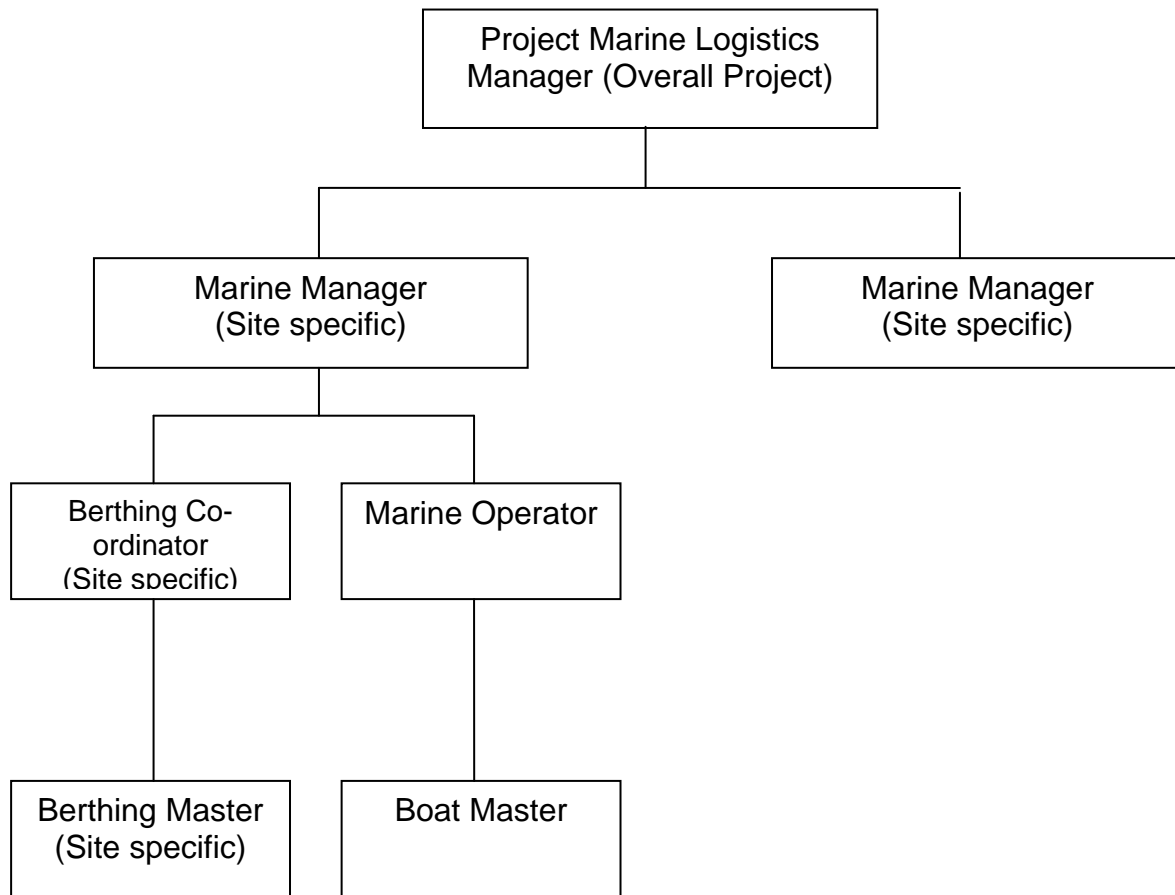

11.1.9 Overall safety on the river is the PLA’s responsibility; the Thames Barrier Navigation Centre assists the PLA by managing and directing traffic from Crayfordness to Teddington Lock.

Abbreviations

AIS	Automatic Identification System
ALARP	As low as reasonably practicable
CSO	Combined sewer overflow
LLAU	Limits of land to be acquired or used
NtM	Notice to Mariners
PLA	Port of London Authority

This page is intentionally left blank

Glossary

Term	Description
above ordnance datum	Ground elevation is measured relative to the mean sea level at Newlyn in Cornwall, referred to as Ordnance Datum (OD), and heights are reported in metres above or below OD.
aggregate	Coarse particulate material used in construction, including sand, gravel, crushed stone, slag, recycled concrete and geosynthetic aggregates. Aggregates are a component of composite materials such as concrete and asphalt concrete. The aggregate serves as reinforcement to add strength to the overall composite material.
baseline	The existing conditions against which the likely significant effects of a proposed development are assessed.
bathymetric	Of or relating to measurements of the depths of oceans or lakes.
campshed	An area of stone, concrete or timber lain on the river/sea bed that is exposed at low tide to allow vessels to rest safely and securely in place.
cast <i>in situ</i> concrete	Concrete (mass or reinforced) that requires a 'shutter' or similar temporary works to facilitate the casting process, until the concrete has gained sufficient strength to dispense with any temporary works.
catchment	The area from which surface water and/or groundwater collects and contributes to the flow of a river, abstraction or other specific discharge boundary. Can be prefixed by 'surface water' or 'groundwater' to indicate the specific nature of the catchment.
Chalk	In England, Chalk topographically forms what are known as the 'Downs' in southern and eastern counties. It is comprised of a sequence of mainly soft, white, very fine-grained, extremely pure limestones that are commonly 300 to 400m thick. These rocks consist mainly of coccolith biomicrites formed from the skeletal elements of minute planktonic green algae, associated with varying proportions of larger microscopic fragments of bivalves, foraminifera and ostracods. In the project area, chalk is firm, white, fine-grained limestone with conspicuous semi-continuous nodular and tabular flint seams.
claystone	A geological term used to describe a clastic sedimentary rock that is composed primarily of clay-sized particles (less than 1/256 millimetre in diameter). Claystone does not refer to rocks that are laminated or

Term	Description
	easily split into thin layers called clay shales. Claystones are a fully-hardened material that is distinct from mudstones, which are partly hardened muds that slake when wetted.
Code of construction practice (CoCP)	A document that sets out control measures to be adopted during the construction period.
cofferdam	A temporary wall that is constructed around the outside of a working area within a river that is then pumped dry. The inside of the cofferdam can be filled to create a safe working area.
combined sewer	A sewer that conveys both rainwater and wastewater of domestic or industrial origin.
combined sewer overflow (CSO)	A structure, or series of structures, that allows sewers that carry both rainwater and wastewater to overflow into a river when at capacity during periods of heavy rainfall. The flows are discharged to river in order to prevent the sewers backing up and flooding streets or houses. Flows may discharge by gravity or by pumping.
conditions (or 'planning conditions')	Conditions attached to a planning or DCO permission to limit, control or direct the manner in which a development is carried out.
confirmation of DCO	The point at which the minister approves the DCO. The powers contained in the DCO may then be used (assuming there is no appeal).
confluence	A gathering, flowing, or meeting together at a juncture or point.
connection tunnel	A tunnel that connects a drop shaft to the main tunnel.
construction site	The area of a site used during the construction phase.
CSO site	A site that contains the CSO interception chambers, connection culverts and the drop shaft from which the connection tunnel is built. Each site needs to be able to provide enough space for all construction-related activities, which would vary depending on the diameter of the shaft and method of tunnel construction.
culvert	A covered structure that conveys a flow under a road, railroad or other obstruction. Culverts are mainly used to divert stream or rainfall run-off to prevent erosion or flooding on highways.
de-aeration chamber	An area within the shaft and/or associated pipe work where air is removed from liquids.
de-aeration ducting	The connection between the de-aeration tunnel back to the CSO drop shaft.

Term	Description
de-aeration tunnel	An area within the tunnel where air is removed from liquids (horizontal de-aeration).
Development Consent Order (DCO)	An order under the Planning Act 2008 approving a development that is or forms part of a Nationally Significant Infrastructure Project. The order can grant planning permission and compulsory purchase powers. The order is granted by the Planning Inspectorate.
diaphragm wall	A diaphragm wall is a reinforced concrete retaining wall constructed <i>in situ</i> . A deep trench is excavated and supported with bentonite slurry, and then reinforcing material (normally steel) is inserted into the trench. Concrete is poured into the trench and only after this can excavation in front of the retained earth commence.
discharge point to river	Where combined sewage is released into the river.
draft limit of land to be acquired or used	The extent of land that may need to be used or acquired, or over which rights may need to be obtained in order to carry out essential works.
drive site	A main tunnel site that contains the shaft from which the tunnel boring machine is 'driven' forward, ie, starts from. Excavated material is removed from and segments are fed into the tunnel via the shaft at the drive site.
drop shaft	A circular, vertical concrete structure to drop flows from a CSO to a main tunnel. Drop shafts also provide access to construct the connection tunnels.
encroachment	With regards to the Thames Tideway Tunnel project, this refers to the extent that proposed structures extend into the river or foreshore.
excavated material	The earth/soil/ground material removed when shafts, tunnels and other structures are excavated. Excavated material can be either topsoil, subsoil or other material, such as rock, etc.
fill	Material required to raise existing ground levels. This may comprise 'cut' material generated within a site or imported material.
fluvial	The processes associated with rivers and streams and the deposits and landforms they create.
foreshore	Ground uncovered by a river when the tide is low.
ground treatment	A range of measures to improve the properties of the naturally occurring ground or to counter the potential pore water pressure changes arising from underground working/excavations in order to facilitate tunnel or shaft construction and/or reduce ground movement caused by works.

Term	Description
impact	A physical or measurable change to the environment that is attributable to the Thames Tideway Tunnel project.
interception chamber	<p>A structure constructed around an existing combined sewer that diverts storm water from the sewer into a new system of structures to transfer storm water flow to a sewage treatment works.</p> <p>Transferring the flow from the existing sewer to the sewage treatment works requires a series of other structures including:</p> <ul style="list-style-type: none"> • connection culvert: a covered channel structure to connect the interception chamber to the drop shaft • drop shaft: a vertical circular structure used to drop the flow down to the main tunnel level and connect the connection culvert to the connection tunnel • connection tunnel: a tunnel that connects the drop shaft to the main tunnel • main tunnel: the tunnel that transfers the flows from the connection tunnels to Abbey Mills Pumping Station, where they are transferred to Beckton Sewage Treatment Works via the Lee tunnel • pumping station: a vertical circular structure with pumps at the bottom is used to lift storm water flows up to the sewage treatment works.
main tunnel	The large diameter tunnel from Acton Storm Tanks to Abbey Mills.
main tunnel site	A site from which the main tunnel would be built. Each site needs to provide enough space for all construction-related activities, which would vary depending on the type of tunnel boring machine used and whether the site is a drive site, double drive site or reception site.
mitigation measures	Proposed actions to prevent or reduce adverse effects arising from the whole or specific elements of a development.
modelling	Simulation of a proposed design (eg, hydraulic modelling of a drainage network, physical modelling of drop shafts or odour modelling, etc).
morphology	The branch of geology that studies the characteristics, configuration and evolution of rocks and land forms.
precast concrete segmental lining	Tunnel or shaft lining composed of precast, usually reinforced, concrete elements (segments) designed to form a specific shape, normally circular.
pumping station	A vertical structure with pumps used to lift storm waterflows up to a sewer at a higher level or into a sewage treatment

Term	Description
	works.
reach	A section of river between two points.
safeguarded wharf	A wharf that is protected by the Mayor of London and the Port of London Authority, to ensure that it is retained as a working wharf and protected from redevelopment into other uses.
scour	Movement of riverbed materials due to the force of the water.
secant piles	<p>Alternate piles in-filled with concrete to form a water-tight retaining wall.</p> <p>A sub-surface barrier installed around construction sites in order to control inflows of shallow groundwater typically composed of intersecting concrete or overlapping shafts of concrete.</p>
secondary lining	A second, internal lining of the tunnel to provide additional strength.
segments	Multiple precast concrete segments made in factories that are joined together to build a tunnel. Shafts are also sometimes constructed from segments.
slipway	A sloping surface leading down to a body of water from which boats may be launched.
Thames Tideway Tunnel project	<p>The Thames Tideway Tunnel project comprises a main tunnel that would run from west to east London that would be integrated with the existing sewerage system via connection tunnels in order to control 34 ‘unsatisfactory’ CSOs. These tunnels would then store and transfer the intercepted flows to Beckton Sewage Treatment Works.</p> <p>The project comprises two principal elements:</p> <ul style="list-style-type: none"> • tunnels: <ul style="list-style-type: none"> ○ the main tunnel ○ connection tunnels. • sites: <ul style="list-style-type: none"> ○ main tunnel sites ○ CSO sites ○ Beckton Sewage Treatment Works ○ system modification sites.
Thames Water	Thames Water Utilities Ltd. The <i>Draft Development Consent Order</i> (DCO) contains an ability for Thames Water to transfer powers to an Infrastructure Provider (as defined in article 2(1) of the DCO) and/or another body, with the

Glossary

Term	Description
	consent of the Secretary of State.
third-party liaison	Consultation/liaison with third-parties regarding information gathering processes (eg, requests for third-party information, access for site investigations, consultation with highway management units regarding ground investigations, etc).
tidal excursion	The length of river channel that is swept by water from a discharge point in one tidal cycle. In the case of the tidal Thames, this is considered to be 13km up and downstream of the river's discharge point.
Tideway	The tidal area of the Thames (ie, from Teddington to the Thames Estuary).
valve chamber	An underground structure on the sewer system that contains valves used to isolate the flow between different parts of the sewerage system. For example, flap valves prevent flow from the river travelling back up the sewer or into tunnels.
works	All construction work associated with the construction of the Thames Tideway Tunnel project.

Appendices

List of appendices in order

Appendix A: Project drawings

Appendix B: River usage survey

This page is intentionally left blank

Thames Tideway Tunnel
Thames Water Utilities Limited



Application for Development Consent

Application Reference Number: WWO10001

Navigational Issues and Preliminary Risk Assessment

Doc Ref: **7.20.01**

Putney Embankment Foreshore

Appendix A

APFP Regulations 2009: Regulation **5(2)(q)**

Hard copy available in

Box **57** Folder **A**
January 2013

**Thames
Tideway Tunnel**



Creating a cleaner, healthier River Thames

This page is intentionally blank

Appendix A: Project drawings

Drawing title	Phase
Construction phases - Site set-up	Phase A
Construction phases - Temporary slipway	Phase A
Construction phases - Shaft construction and tunnelling	Phase B
Construction phases - Construction of other structures	Phase C
Construction phases - Site demobilisation	Phase D
Permanent works layout Sheet 1 of 2	Phase E
Permanent works layout Sheet 2 of 2	Phase E
River foreshore zones of working	

This page is intentionally blank

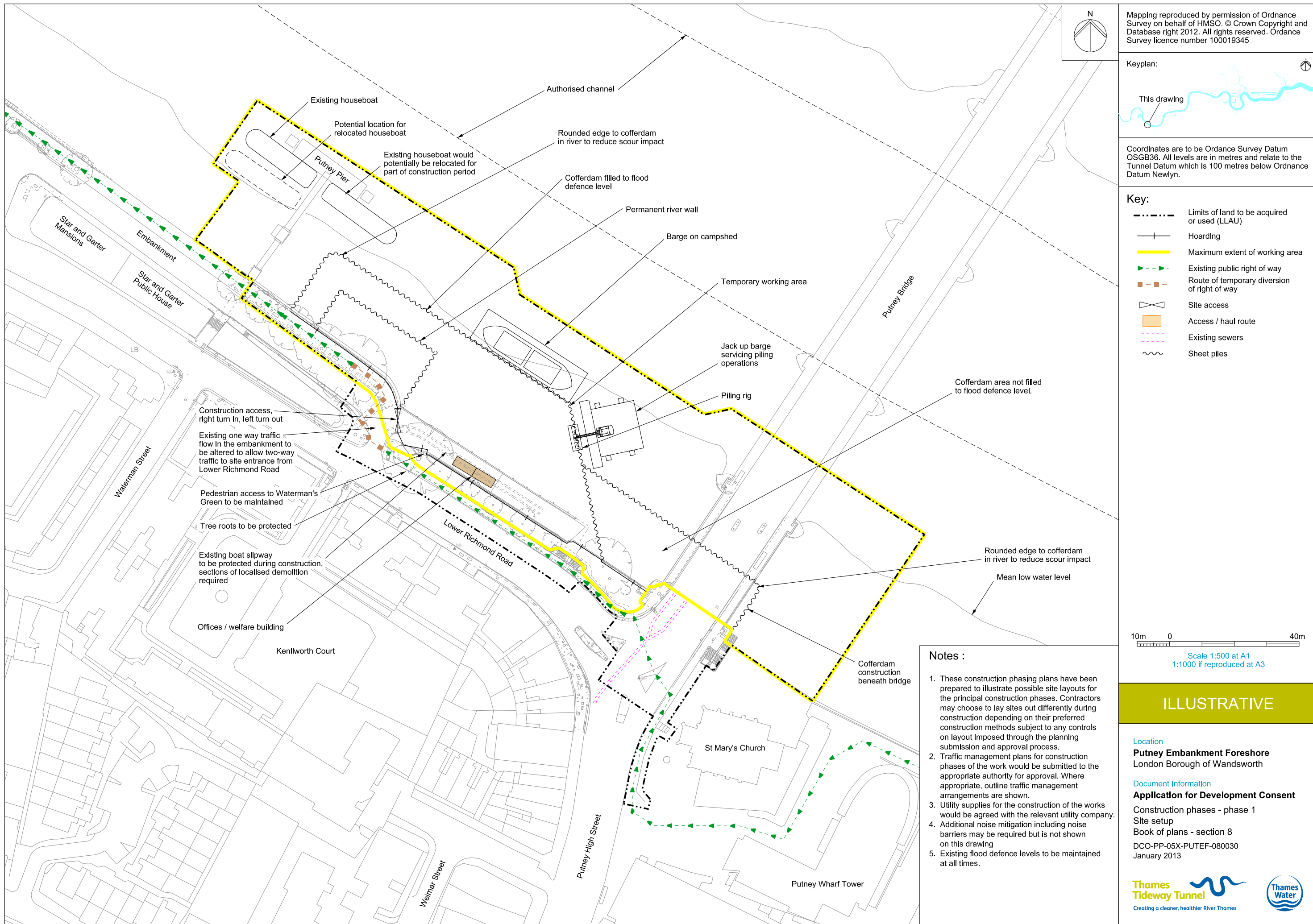

Mapping reproduced by permission of Ordnance Survey on behalf of HMSO. © Crown Copyright and Database right 2012. All rights reserved. Ordnance Survey licence number 100019345



Coordinates are to be Ordnance Survey Datum OSGB36. All levels are in metres and relate to the Tunnel Datum which is 100 metres below Ordnance Datum Newlyn.

Key:

	Limits of land to be acquired or used (LLAU)
	Hoarding
	Maximum extent of working area
	Existing public right of way
	Route of temporary diversion of right of way
	Site access
	Access / haul route
	Existing sewers
	Sheet piles

- Notes :**
1. These construction phasing plans have been prepared to illustrate possible site layouts for the principal construction phases. Contractors may choose to lay sites out differently during construction depending on their preferred construction methods subject to any controls on layout imposed through the planning submission and approval process.
 2. Traffic management plans for construction phases of the work would be submitted to the appropriate authority for approval. Where appropriate, outline traffic management arrangements are shown.
 3. Utility supplies for the construction of the works would be agreed with the relevant utility company.
 4. Additional noise mitigation including noise barriers may be required but is not shown on this drawing
 5. Existing flood defence levels to be maintained at all times.

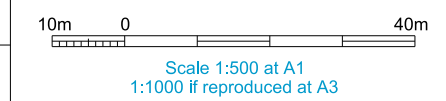

ILLUSTRATIVE

Location
Putney Embankment Foreshore
 London Borough of Wandsworth

Document Information
Application for Development Consent
 Construction phases - phase 1
 Site setup
 Book of plans - section 8
 DCO-PP-05X-PUTEF-080030
 January 2013



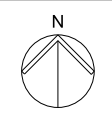

Mapping reproduced by permission of Ordnance Survey on behalf of HMSO. © Crown Copyright and Database right 2012. All rights reserved. Ordnance Survey licence number 100019345



Coordinates are to be Ordnance Survey Datum OSGB36. All levels are in metres and relate to the Tunnel Datum which is 100 metres below Ordnance Datum Newlyn.

- Key:**
- Limits of land to be acquired or used (LLAU)
 - Hoarding
 - Maximum extent of working area
 - Existing public right of way
 - Route of temporary diversion of right of way
 - Site access
 - Access / haul route

- Notes :**
1. These construction phasing plans have been prepared to illustrate possible site layouts for the principal construction phases. Contractors may choose to lay sites out differently during construction depending on their preferred construction methods subject to any controls on layout imposed through the planning submission and approval process.
 2. Traffic management plans for construction phases of the work would be submitted to the appropriate authority for approval. Where appropriate, outline traffic management arrangements are shown.
 3. Utility supplies for the construction of the works would be agreed with the relevant utility company.
 4. Additional noise mitigation including noise barriers may be required but is not shown on this drawing.



ILLUSTRATIVE

Location
Putney Embankment Foreshore
London Borough of Wandsworth

Document Information
Application for Development Consent
Construction phase - Temporary slipway

Book of plans - section 8
DCO-PP-05X-PUTEF-080034
January 2013



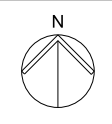
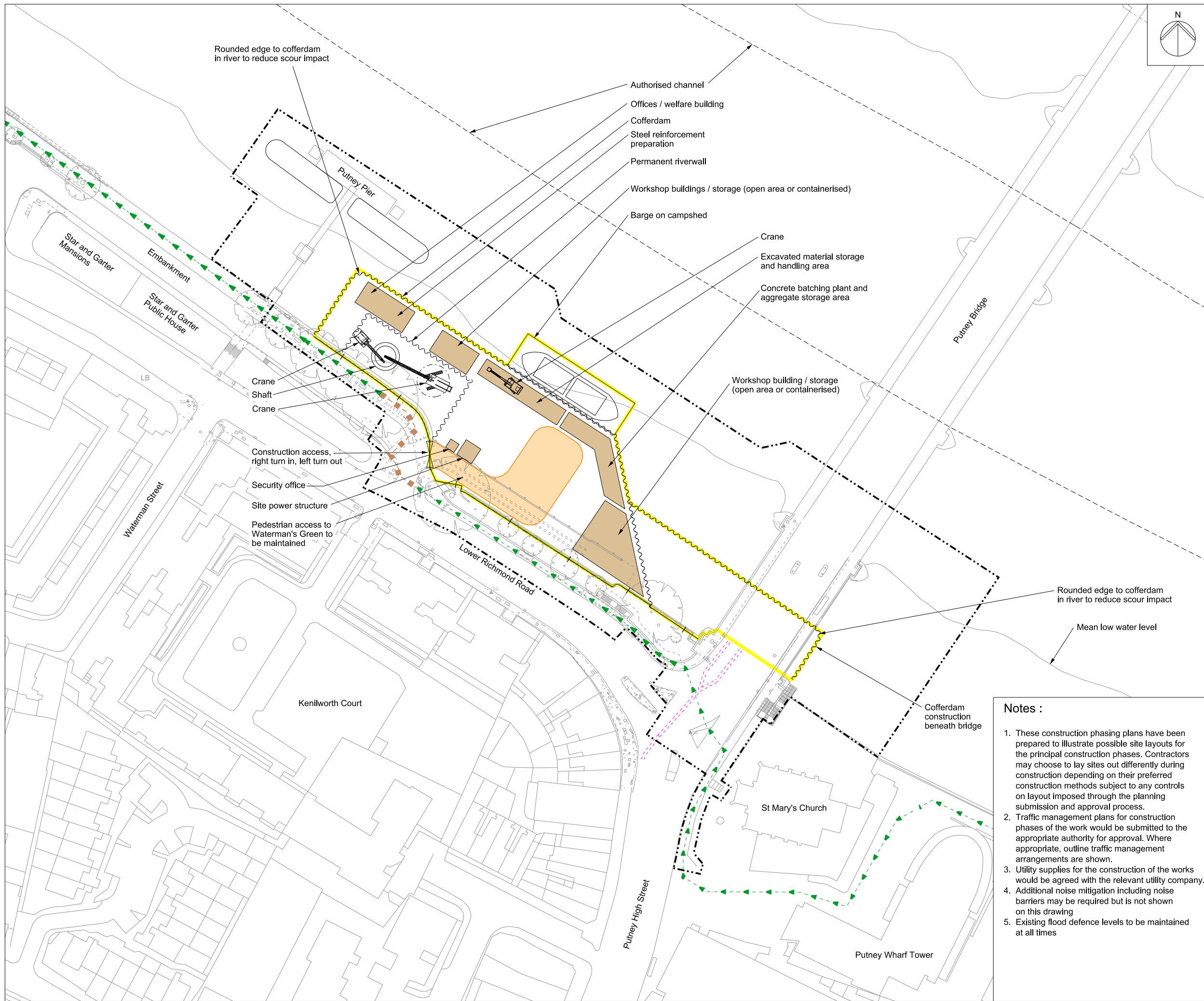

Mapping reproduced by permission of Ordnance Survey on behalf of HMSO. © Crown Copyright and Database right 2012. All rights reserved. Ordnance Survey licence number 100019345

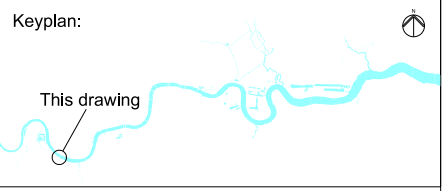

Coordinates are to be Ordnance Survey Datum OSGB36. All levels are in metres and relate to the Tunnel Datum which is 100 metres below Ordnance Datum Newlyn.

Key:

	Limits of land to be acquired or used (LLAU)
	Hoarding
	Maximum extent of working area
	Existing public right of way
	Route of temporary diversion of right of way
	Site access
	Access / haul route
	Existing sewers
	Sheet piles



- Notes :**
1. These construction phasing plans have been prepared to illustrate possible site layouts for the principal construction phases. Contractors may choose to lay sites out differently during construction depending on their preferred construction methods subject to any controls on layout imposed through the planning submission and approval process.
 2. Traffic management plans for construction phases of the work would be submitted to the appropriate authority for approval. Where appropriate, outline traffic management arrangements are shown.
 3. Utility supplies for the construction of the works would be agreed with the relevant utility company.
 4. Additional noise mitigation including noise barriers may be required but is not shown on this drawing
 5. Existing flood defence levels to be maintained at all times

ILLUSTRATIVE

Location
Putney Embankment Foreshore
London Borough of Wandsworth

Document Information
Application for Development Consent
Construction phases - phase 2
Shaft construction & tunnelling
Book of plans - section 8
DCO-PP-05X-PUTEF-080031
January 2013



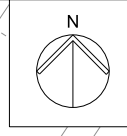
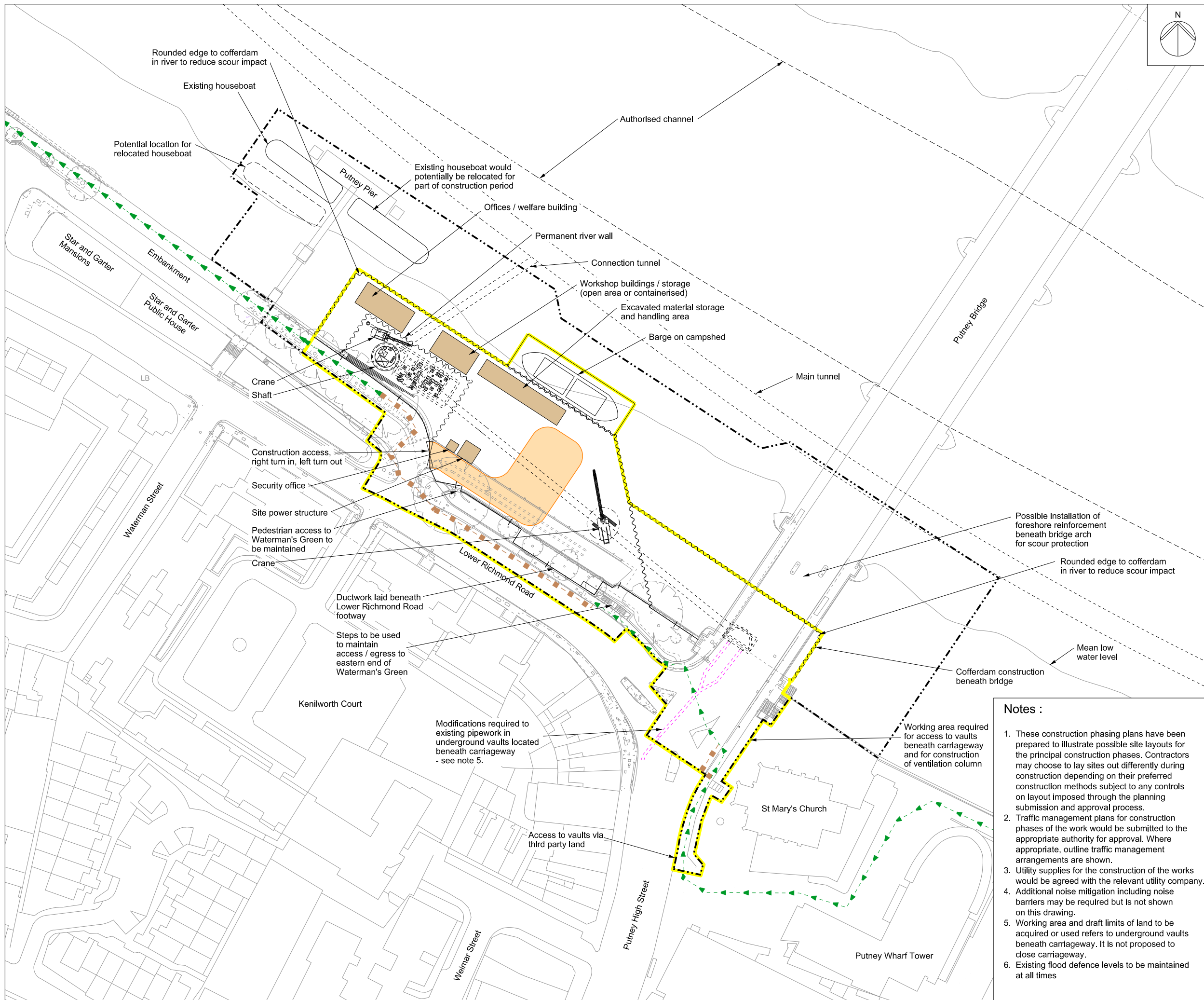

Mapping reproduced by permission of Ordnance Survey on behalf of HMSO. © Crown Copyright and Database right 2012. All rights reserved. Ordnance Survey licence number 100019345



Coordinates are to be Ordnance Survey Datum OSGB36. All levels are in metres and relate to the Tunnel Datum which is 100 metres below Ordnance Datum Newlyn.

- Key:**
- Limits of land to be acquired or used (LLAU)
 - Hoarding
 - Maximum extent of working area
 - Existing public right of way
 - Route of temporary diversion of right of way
 - Site access
 - Access / haul route
 - Existing sewers
 - Sheet piles



Notes :

1. These construction phasing plans have been prepared to illustrate possible site layouts for the principal construction phases. Contractors may choose to lay sites out differently during construction depending on their preferred construction methods subject to any controls on layout imposed through the planning submission and approval process.
2. Traffic management plans for construction phases of the work would be submitted to the appropriate authority for approval. Where appropriate, outline traffic management arrangements are shown.
3. Utility supplies for the construction of the works would be agreed with the relevant utility company.
4. Additional noise mitigation including noise barriers may be required but is not shown on this drawing.
5. Working area and draft limits of land to be acquired or used refers to underground vaults beneath carriageway. It is not proposed to close carriageway.
6. Existing flood defence levels to be maintained at all times

ILLUSTRATIVE

Location
Putney Embankment Foreshore
London Borough of Wandsworth

Document Information
Application for Development Consent
Construction phases - phase 3
Construction of other structures
Book of plans - section 8
DCO-PP-05X-PUTEF-080032
January 2013



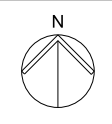
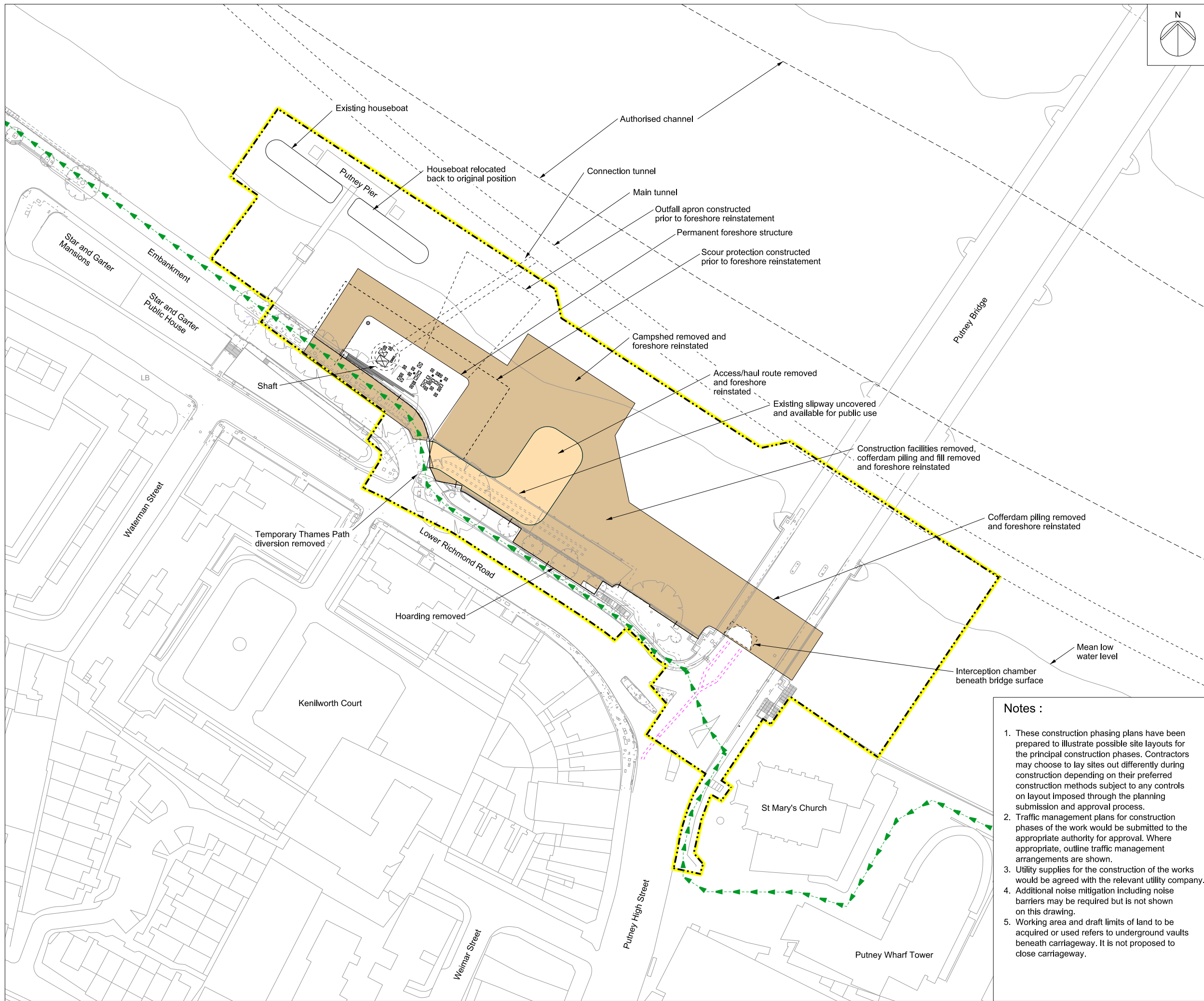

Mapping reproduced by permission of Ordnance Survey on behalf of HMSO. © Crown Copyright and Database right 2012. All rights reserved. Ordnance Survey licence number 100019345

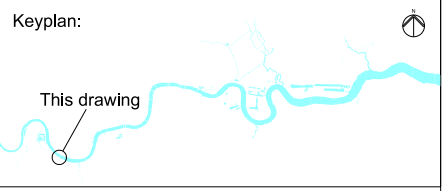

Coordinates are to be Ordnance Survey Datum OSGB36. All levels are in metres and relate to the Tunnel Datum which is 100 metres below Ordnance Datum Newlyn.

Key:

	Limits of land to be acquired or used (LLAU)
	Hoarding
	Maximum extent of working area
	Existing public right of way
	Route of temporary diversion of right of way
	Site access
	Access / haul route
	Existing sewers



- Notes :**
1. These construction phasing plans have been prepared to illustrate possible site layouts for the principal construction phases. Contractors may choose to lay sites out differently during construction depending on their preferred construction methods subject to any controls on layout imposed through the planning submission and approval process.
 2. Traffic management plans for construction phases of the work would be submitted to the appropriate authority for approval. Where appropriate, outline traffic management arrangements are shown.
 3. Utility supplies for the construction of the works would be agreed with the relevant utility company.
 4. Additional noise mitigation including noise barriers may be required but is not shown on this drawing.
 5. Working area and draft limits of land to be acquired or used refers to underground vaults beneath carriageway. It is not proposed to close carriageway.

ILLUSTRATIVE

Location
Putney Embankment Foreshore
London Borough of Wandsworth

Document Information
Application for Development Consent
Construction phases - phase 4
Site demobilisation
Book of plans - section 8
DCO-PP-05X-PUTEF-080033
January 2013



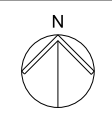
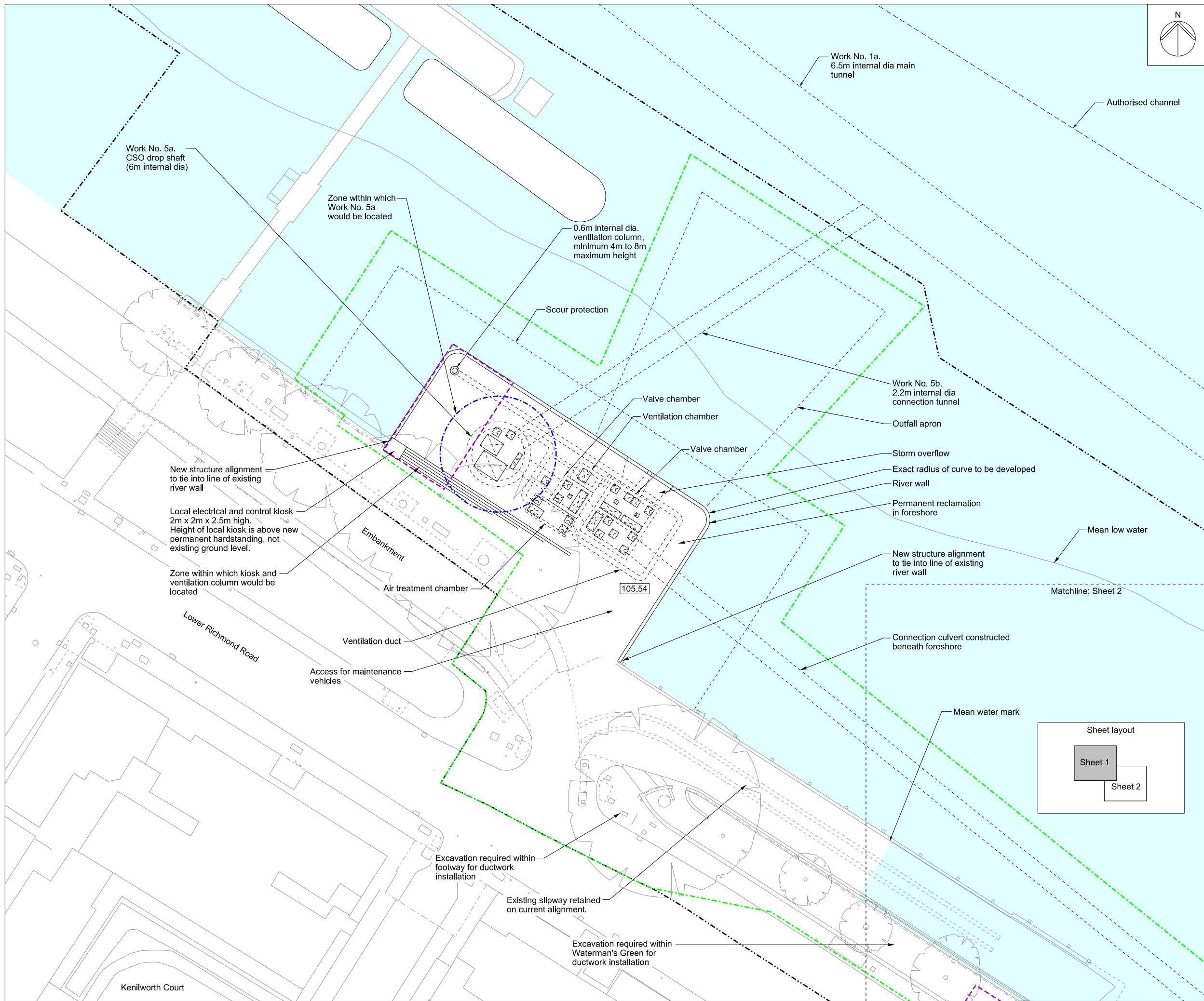

Mapping reproduced by permission of Ordnance Survey on behalf of HMSO. © Crown Copyright and Database right 2012. All rights reserved. Ordnance Survey licence number 100019345



Coordinates are to be Ordnance Survey Datum OSGB36. All levels are in metres and relate to the Tunnel Datum which is 100 metres below Ordnance Datum Newlyn.

- Key:**
- Limits of land to be acquired or used (LLAU)
 - Proposed access cover
 - Proposed level (shown in metres above tunnel datum)
 - Zone within which all permanent site structures would be located
 - Zone within which the shaft would be located
 - Zone within which permanent above ground structures would be located

- Notes:**
1. All dimensions and levels are approximate.
 2. Any discrepancy between the location of structures and the parameters marked on the drawings are due to differences between the Ordnance Survey base and topographical survey base, both of which have been used in the preparation of this drawing.
 3. This drawing shows permanent site structures only. Landscaping hard works and soft works are shown on the Proposed landscape plan and/or Proposed site features plan.
 4. Two electrical and control kiosks are required. One local kiosk situated upon the new permanent hardstanding area and one situated upon Waterman's Green against the listed retaining wall.

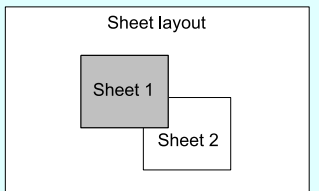
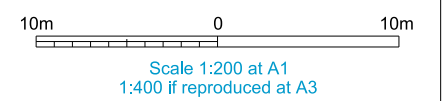

ILLUSTRATIVE

Location
Putney Embankment Foreshore
London Borough of Wandsworth

Document Information
Application for Development Consent
Permanent works layout
Sheet 1 of 2
Book of plans - section 8
DCO-PP-05X-PUTEF-080010
January 2013



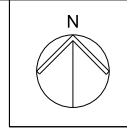

Mapping reproduced by permission of Ordnance Survey on behalf of HMSO. © Crown Copyright and Database right 2012. All rights reserved. Ordnance Survey licence number 100019345



Coordinates are to be Ordnance Survey Datum OSGB36. All levels are in metres and relate to the Tunnel Datum which is 100 metres below Ordnance Datum Newlyn.

- Key:**
- Limits of land to be acquired or used (LLAU)
 - Existing sewers
 - Zone within which all permanent site structures would be located
 - Zone within which permanent above ground structures would be located

- Notes:**
1. All dimensions and levels are approximate.
 2. Any discrepancy between the location of structures and the parameters marked on the drawings are due to differences between the Ordnance Survey base and topographical survey base, both of which have been used in the preparation of this drawing.
 3. This drawing shows permanent site structures only. Landscaping hard works and soft works are shown on the Proposed landscape plan and/or Proposed site features plan.

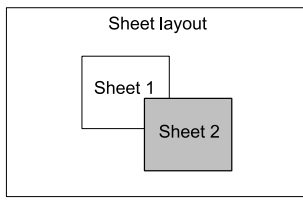
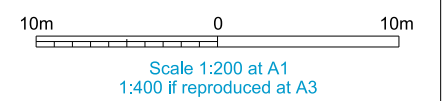

ILLUSTRATIVE

Location
Putney Embankment Foreshore
London Borough of Wandsworth

Document Information
Application for Development Consent
Permanent works layout
Sheet 2 of 2
Book of plans - section 8
DCO-PP-05X-PUTEF-080011
January 2013

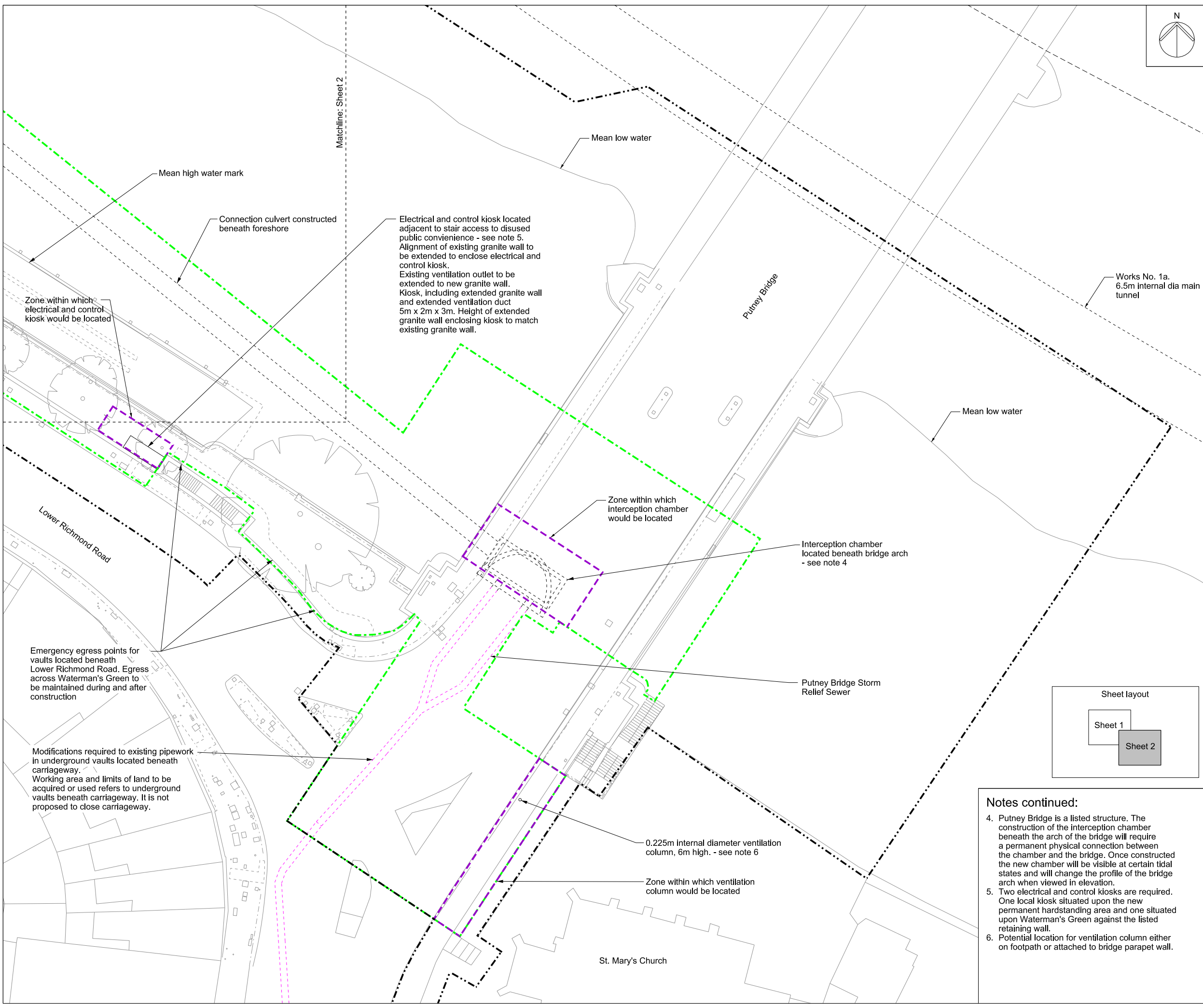

Matchline: Sheet 2

Mean high water mark

Connection culvert constructed beneath foreshore

Electrical and control kiosk located adjacent to stair access to disused public convenience - see note 5. Alignment of existing granite wall to be extended to enclose electrical and control kiosk. Existing ventilation outlet to be extended to new granite wall. Kiosk, including extended granite wall and extended ventilation duct 5m x 2m x 3m. Height of extended granite wall enclosing kiosk to match existing granite wall.

Zone within which electrical and control kiosk would be located

Zone within which interception chamber would be located

Interception chamber located beneath bridge arch - see note 4

Emergency egress points for vaults located beneath Lower Richmond Road. Egress across Waterman's Green to be maintained during and after construction

Modifications required to existing pipework in underground vaults located beneath carriageway. Working area and limits of land to be acquired or used refers to underground vaults beneath carriageway. It is not proposed to close carriageway.

Putney Bridge Storm Relief Sewer

0.225m internal diameter ventilation column, 6m high. - see note 6

Zone within which ventilation column would be located

St. Mary's Church

- Notes continued:**
4. Putney Bridge is a listed structure. The construction of the interception chamber beneath the arch of the bridge will require a permanent physical connection between the chamber and the bridge. Once constructed the new chamber will be visible at certain tidal states and will change the profile of the bridge arch when viewed in elevation.
 5. Two electrical and control kiosks are required. One local kiosk situated upon the new permanent hardstanding area and one situated upon Waterman's Green against the listed retaining wall.
 6. Potential location for ventilation column either on footpath or attached to bridge parapet wall.

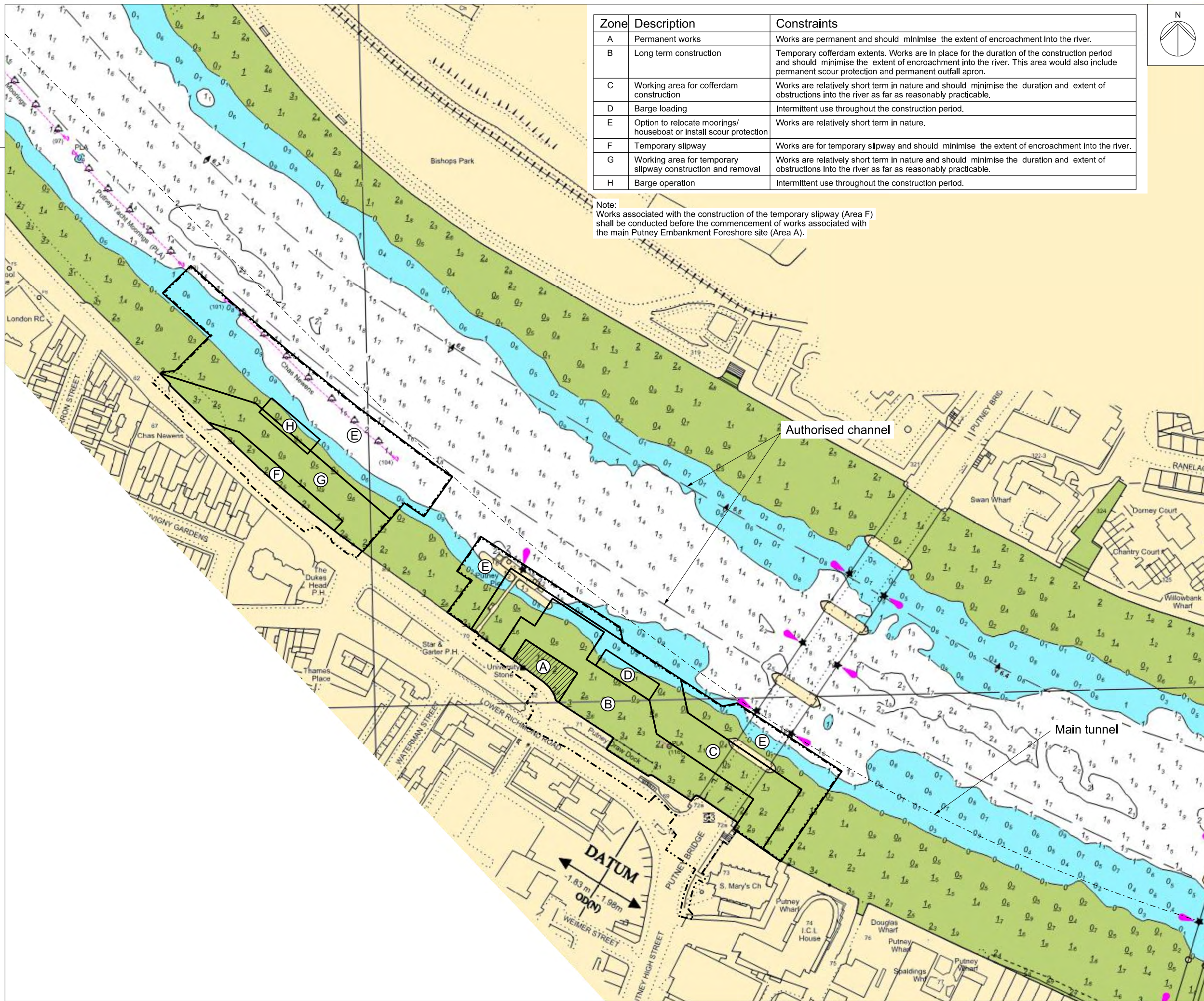

Zone	Description	Constraints
A	Permanent works	Works are permanent and should minimise the extent of encroachment into the river.
B	Long term construction	Temporary cofferdam extents. Works are in place for the duration of the construction period and should minimise the extent of encroachment into the river. This area would also include permanent scour protection and permanent outfall apron.
C	Working area for cofferdam construction	Works are relatively short term in nature and should minimise the duration and extent of obstructions into the river as far as reasonably practicable.
D	Barge loading	Intermittent use throughout the construction period.
E	Option to relocate moorings/ houseboat or install scour protection	Works are relatively short term in nature.
F	Temporary slipway	Works are for temporary slipway and should minimise the extent of encroachment into the river.
G	Working area for temporary slipway construction and removal	Works are relatively short term in nature and should minimise the duration and extent of obstructions into the river as far as reasonably practicable.
H	Barge operation	Intermittent use throughout the construction period.

Note:
Works associated with the construction of the temporary slipway (Area F) shall be conducted before the commencement of works associated with the main Putney Embankment Foreshore site (Area A).

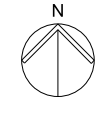

Mapping reproduced by permission of Ordnance Survey on behalf of HMSO. © Crown Copyright and Database right 2012. All rights reserved. Ordnance Survey licence number 100019345



Coordinates are to be Ordnance Survey Datum OSGB36. All levels are in metres and relate to the Tunnel Datum which is 100 metres below Ordnance Datum Newlyn.

Key:
 - - - - - Limits of land to be acquired or used (LLAU)

Notes:
 1. All levels are in metres and relate to chart datum.
 2. Background information shown on this drawing is taken from:
 River Thames - Barn Elms Reach (Lower)
 Port of London Authority Hydrographic Service
 H.O. Ref. No....113-312-013....Date....30/06/2010

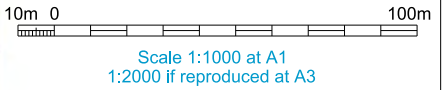

FOR INFORMATION

Location
Putney Embankment Foreshore
 London Borough of Wandsworth

Document Information
Application for Development Consent
 River foreshore zones of working

DCO-PP-05X-PUTEF-080038
 January 2013



Thames Tideway Tunnel
Thames Water Utilities Limited



Application for Development Consent

Application Reference Number: WWO10001

Navigational Issues and Preliminary Risk Assessment

Doc Ref: **7.20.01**

Putney Embankment Foreshore

Appendix B

APFP Regulations 2009: Regulation **5(2)(q)**

Hard copy available in

Box **57** Folder **A**
January 2013

**Thames
Tideway Tunnel**



Creating a cleaner, healthier River Thames

This page is intentionally blank

Appendix B: River usage survey at Putney

Relevant sections taken from:
River Usage survey report by Peter Brett Associates
June 2012 Project Ref: 26652/001

B.1 Survey results

B.1.1 This chapter comprises two sections, a) the vessel counts and commentary; and b) the pedestrian counts and commentary.

River vessel survey

B.1.2 The results are presented by section of the River surveyed, namely:

- a. Vicinity of Putney Pier
- b. Vicinity of Wandsworth RQ Pier
- c. Vicinity of Victoria Embankment FS
- d. Vicinity of Blackfriars Bridge FS

Survey locations

B.1.3 This survey involved the use of cameras which were positioned at three locations in the vicinity of Putney Pier. The overall location of the survey site and its context are shown in Figure B.1.

Figure B.1 Survey location at Putney Bridge

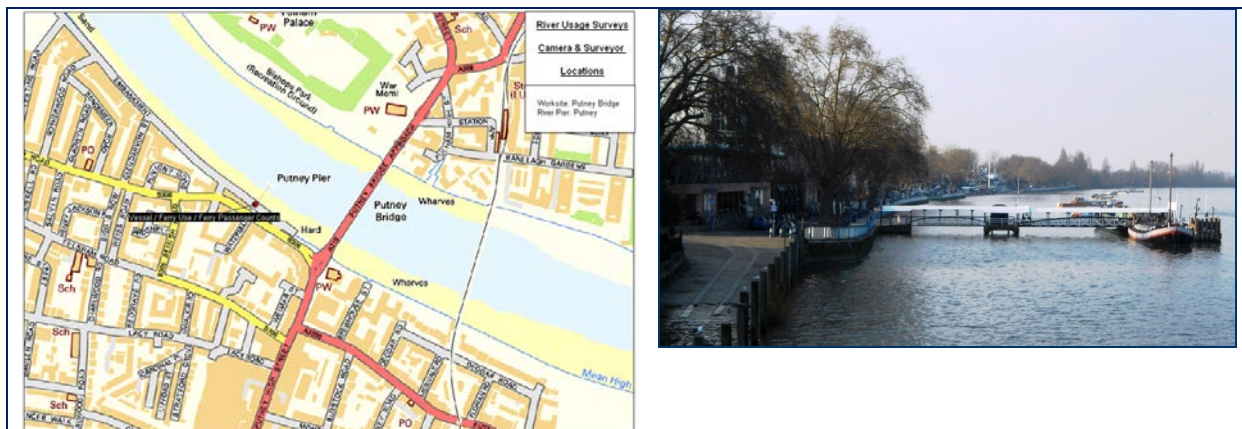

B.1.4 With regards to the cameras, one was attached to a lamp column located on the Embankment, directly opposite the pedestrian entrance to the pier. A second camera was attached to a lamp column located upstream of the pier along the Embankment. This camera recorded all activity taking place on the river, including vessels docking at the pier. The third camera was attached to a lamp column placed downstream of the pier and recorded activity on the river, as well as vessels docking at the pier. Continuous recordings were made over the survey period.

Overall number of craft

- B.1.5 The combined number of craft that arrived and departed (each counted a separate movement) and passed Putney Pier over the four day survey totals 530 vessels. This comprises 498 craft passing the pier and 18 movements to and from it. The distribution of these vessels arriving, departing and passing the pier between 0700 and 1900 is shown in Table B.2 and Figure B.2.

Table B.1 Distribution of all craft at Putney Pier

Time	Percentage
07:00 - 08:00	5%
08:00 - 09:00	7%
09:00 - 10:00	11%
10:00 - 11:00	10%
11:00 - 12:00	10%
12:00 - 13:00	9%
13:00 - 14:00	3%
14:00 - 15:00	12%
15:00 - 16:00	11%
16:00 - 17:00	11%
17:00 - 18:00	7%
18:00 - 19:00	5%

Figure B.2 Distribution of all raft at Putney Pier

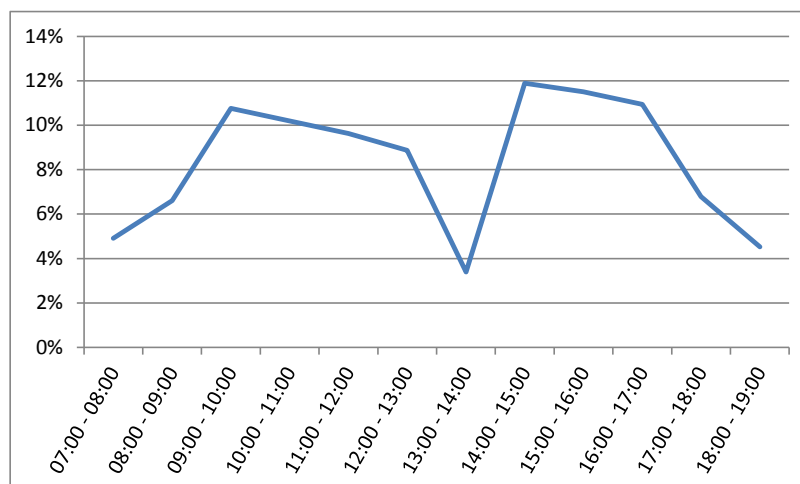

- B.1.6 A breakdown of the total number of craft passing the pier on the survey days is shown in Table B.3.

Table B.2 Craft passing Putney Pier

Day	Total Craft
Thursday 10 May 2012	43
Friday 11 May 2012	32
Saturday 12 May 2012	216
Sunday 13 May 2012	207
Total over survey	498

B.1.7 The number of craft movements to and from Putney Pier over the survey period is relatively low (18). A breakdown by dates is shown in Table B.4.

Table B.3 Craft movements (arriving/departing/mooring) at Putney Pier

Day	Total Craft
Thursday 10 May 2012	4
Friday 11 May 2012	6
Saturday 12 May 2012	3
Sunday 13 May 2012	5
Total over survey	18

Craft visiting the pier

B.1.8 This analysis reviews the type of craft visiting the pier and indicates the number of times this occurred for each particular class of craft. The variety and number of craft that visited Putney Pier is shown in Table B.5.

Table B.4 Numbers of craft by class visiting Putney Pier

Vessel type	10 May	11 May	12 May	13 May	Total
Launch	1	1	2	2	6
Motor Dinghy	0	1	1	0	2
Narrow Boat	1	0	0	0	1
Private Cruiser	0	0	0	2	2
River Cruise	2	4	0	0	6
Tug	0	0	0	1	1
Total	4	6	3	5	18

B.1.9 The largest of the craft to stop at the pier were river cruise vessels.

Dwell time at pier

B.1.10 The length of time that craft were moored at the pier between arrival and departure is shown in Table B.6.

Table B.5 Average time vessels are moored at Putney Pier

Date	Average time moored
10 May	00:26:52
11 May	00:28:16
12 May	03:07:35
13 May	00:52:01

- B.1.11 For most craft it is not possible to determine the reason why they are moored, although for river cruises it is to pick up and drop off passengers at the beginning and end of tours. For this category the time appears to be about 30 minutes, while the last visit in the late afternoon is about 2 minutes (but this could increase during the summer period when potentially more passengers may be on board the boat).

Direction of arrival and departure at the pier

- B.1.12 This analysis considers the number of craft movements to and from the piers, a movement being either an arrival or departure. There are a number of factors that will determine the direction (approaching from upstream or downstream of pier) which craft will arrive and depart a pier. These are considered to be:
- Private craft navigate from a starting point was up or downstream of the pier
 - The schedule of a commercial service has stops up or downstream of the pier
 - Other commercial craft need to travel to or from locations up or downstream of the pier
- B.1.13 For scheduled passenger services this direction will not alter and can be predicted, but for other commercial and private craft movements the direction is more random.
- B.1.14 The tables below show the direction craft travel to and from Putney Pier, broken down into activity on Thursday and Friday, Saturday and Sunday and an overall summary.
- B.1.15 During Thursday and Friday there were a total of 20 arrivals and departures at Putney Pier.

**Table B.6 Direction of craft movement at Putney Pier - Thursday and Friday
(10th/11th May)**

Time	Upstream Arr.	Upstream Dep.	Downstream Arr.	Downstream Dep.	Total
07:00 - 08:00	4	1	0	1	6
08:00 - 09:00	0	0	0	2	2
09:00 - 10:00	0	0	0	0	0
10:00 - 11:00	0	0	1	0	1
11:00 - 12:00	1	1	0	0	2
12:00 - 13:00	0	0	0	1	1
13:00 - 14:00	0	0	0	0	0
14:00 - 15:00	2	1	0	1	4
15:00 - 16:00	0	0	0	0	0
16:00 - 17:00	0	0	0	0	0
17:00 - 18:00	0	0	0	0	0
18:00 - 19:00	2	0	0	2	4
Total	9	3	1	7	20

B.1.16 During Saturday and Sunday there were also a total of 16 arrivals and departures at Putney Pier.

Table B.7 Direction of craft movement at Putney Pier - Saturday and Sunday (12th/13th May)

Time	Upstream Arr.	Upstream Dep.	Downstream Arr.	Downstream Dep.	Total
07:00 - 08:00	0	0	0	0	0
08:00 - 09:00	2	0	0	0	2
09:00 - 10:00	0	1	0	0	1
10:00 - 11:00	0	1	1	1	3
11:00 - 12:00	0	0	0	0	0
12:00 - 13:00	2	0	0	0	2
13:00 - 14:00	0	0	0	0	0
14:00 - 15:00	1	0	0	0	1
15:00 - 16:00	1	1	0	2	4
16:00 - 17:00	0	0	0	0	0
17:00 - 18:00	0	0	1	2	3
18:00 - 19:00	0	0	0	0	0
Total	6	3	2	5	16

B.1.17 Over the four day survey period there was an overall total of 36 arrivals and departures at Putney Pier.

Table B.8 Direction of craft movement at Putney Pier - All days (10th/13th May)

Time	Upstream Arr.	Upstream Dep.	Downstream Arr.	Downstream Dep.	Total
07:00 - 08:00	4	1	0	1	6
08:00 - 09:00	2	0	0	2	4
09:00 - 10:00	0	1	0	0	1
10:00 - 11:00	0	1	2	1	4
11:00 - 12:00	1	1	0	0	2
12:00 - 13:00	2	0	0	1	4
13:00 - 14:00	0	0	0	0	0
14:00 - 15:00	3	1	0	1	5
15:00 - 16:00	1	1	0	2	4
16:00 - 17:00	0	0	0	0	0
17:00 - 18:00	0	0	1	2	3
18:00 - 19:00	2	0	0	2	4
Total	15	6	3	12	36

B.1.18 Of the 18 arrivals, 7 included those performing a U-turn manoeuvre when leaving the river channel in order to moor at the pier. This manoeuvre is presumably made to assist the boat's master moor against a flowing current (e.g. such as on a rising tide).

Craft passing the pier

B.1.19 In addition to recording the number of craft visiting the pier, a record has also been made of the craft that pass the pier going up and down the River. Figure B.3 shows the total number and type of craft that passed the pier each day.

Figure B.3 All craft passing Putney Pier over the course of the survey (10th to 13th May)

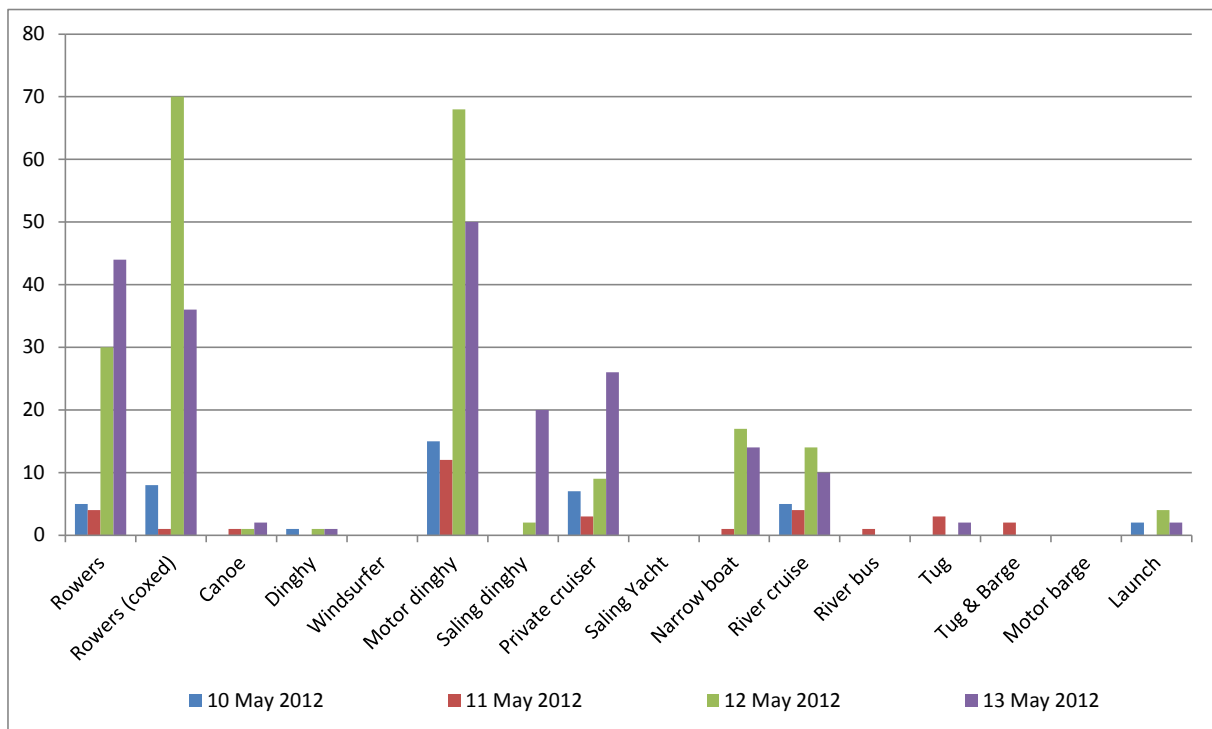

- B.1.20** The craft most frequently passing or in the proximity of the pier over the four day period were 'rowers' (craft such as sculls and eights); however, their presence was chiefly on the weekend days. The next most frequently recorded craft were motor dinghies. The high number of observations for this type of craft (typically small inflatables) is due to them accompanying rowers as they go up and down the river.
- B.1.21** An important point to note about the rowing activity at this location is the tendency of many crews to use the vicinity of Putney Pier as a turning point. The rowers approach the area from upstream, turn 180 degrees and resume upstream. It was also observed that groups of canoeists travelling up and downstream pass inshore of the pier and under the superstructure of the pier's gangway connecting it to the bank when arriving or departing the river access ramp which is visible in Figure B.1.
- B.1.22** On average, the number of craft passing the pier per hour is very low, but this masks the fact that in any one hour a pier can experience a high concentration of movements. Table B.10 provides an indication of the average rate by the number of hours in which craft were recorded and for the whole survey period 07:00 to 19:00.

Table B.9 Average number of craft passing Putney Pier per hour

Day	Overall daily average (07:00 to 19:00)	Average for only the relevant hours	Highest number in anyone hour
10 May	0.51	1.72	4
11 May	0.27	1.39	3
12 May	1.80	4.41	19
13 May	1.57	3.51	14

Pedestrian activity

- B.1.23 The pier is accessed from Embankment, as shown in Figure B.4, and can be approached from the west (upstream), east and south directions. Generally, there is a relatively low flow of people passing the entrance and no congestion on the footpath forms under 'normal' conditions.

Figure B.4 Entrance to Putney Pier



- B.1.24 Over the survey period a total 281 people entered and exited the pier entrance. The largest number using the pier was on the Thursday (10th May) and Friday, when 233 people were recorded. However, this included a single large party of about 90 people who appeared to be on a special charter trip.
- B.1.25 The busiest periods of use on the Thursday and Friday are between 07:00 and 08:00, and 16:00 and 17:00, but the numbers are low, averaging 8 and 3 people, respectively. Across all the other times for both days the average is about no more than 1 person, if the party of 90 is not included. Table B.11 shows the distribution of people entering/exiting the pier during the peak and off-peak periods.

Table B.10 Total number of people entering/existing Putney Pier on 10th/11th May 2012

Time	Entry to Pier			Exit from Pier		
	From West	From East	From South	To West	To East	To South
0700 - 1000	29	9	3	0	1	2
1000 - 1600	6	114	4	7	7	6
1600 - 1900	6	16	3	8	10	2
Total	41	139	10	15	18	10

B.1.26 During the weekend the number of people using entering or existing the pier is lower than the week days, with a total of 48 people recorded as moving onto and off of the pier. There is very little morning activity before 10:00 and most people (40) are active between 10:00 and 19:00. Table B.12 shows the distribution of people entering/existing the pier during the peak and off-peak periods.

Table B.11 Total number of people entering/existing Putney Pier on 12th/13th May 2012

Time	Entry to Pier			Exit from Pier		
	From West	From East	From South	To West	To East	To South
0700 - 1000	0	3	0	4	1	0
1000 - 1600	8	6	1	9	5	2
1600 - 1900	2	3	0	2	2	0
Total	10	12	1	15	8	2

B.1.27 The footpath does not become noticeably busier at the weekend, although it was noted that a group of about 7 canoeists did use the area immediately opposite the entrance to prepare themselves and their canoes for use on the river.

Summary of Putney survey

B.1.28 The river and pedestrian activity in the vicinity of the TT Putney Bridge site is relatively low. During the week there are a number of boats that pickup and drop off passengers in the morning and evening commuting periods. At weekends there are no similar services, but the river becomes busier with leisure craft particularly, rowers, canoeists and dinghies. The location

appears to be a point on the river where rowers turn and canoeists enter the water using Putney Bridge ramp.

Bankside Pier					
Motor Dinghy	0	0	1	1	2
Private Cruise	0	0	1	0	1
River Cruise	8	11	17	1	37
River Bus	71	71	60	0	202
Launch	4	3	0	7	14
Total	83	85	79	9	256

B.1.29 The largest of the craft to stop at the piers were river bus vessels.

B.1.30 The length of time that craft are moored at the pier between arrival and departure is shown in Table B.46. Note these times exclude any craft which were not observed arriving at the pier prior to departing or did not depart from the pier at the end of the survey, as these tended to moor at the pier for a much longer time - e.g. over five hours.

B.2 Conclusions

B.2.1 From the analysis of the survey result it is concluded that:

- a. Putney experiences a relatively low number of arrivals and departures by craft.
- b. It would appear the number of craft passing Putney Pier is relatively low on working days, but rises substantially at weekends when a large number of leisure users take to the water.

Copyright notice

Copyright © Thames Water Utilities Limited January 2013.
All rights reserved.

Any plans, drawings, designs and materials (materials) submitted by Thames Water Utilities Limited (Thames Water) as part of this application for Development Consent to the Planning Inspectorate are protected by copyright. You may only use this material (including making copies of it) in order to (a) inspect those plans, drawings, designs and materials at a more convenient time or place; or (b) to facilitate the exercise of a right to participate in the pre-examination or examination stages of the application which is available under the Planning Act 2008 and related regulations. Use for any other purpose is prohibited and further copies must not be made without the prior written consent of Thames Water.

Thames Water Utilities Limited

Clearwater Court, Vastern Road, Reading RG1 8DB

The Thames Water logo and Thames Tideway Tunnel logo are © Thames Water Utilities Limited. All rights reserved.

DCO-DT-000-ZZZZ-072001

